

OLYMPUS

DIGITAL CAMERA

TG-5

Instruction Manual

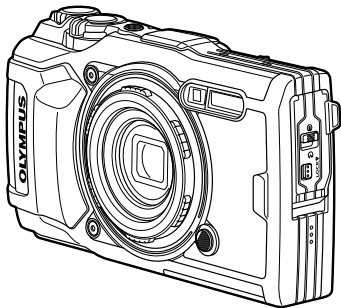

CE

Model No. : IM005

- Thank you for purchasing an Olympus digital camera. Before you start to use your new camera, please read these instructions carefully to enjoy optimum performance and a longer service life. Keep this manual in a safe place for future reference.
- We recommend that you take test shots to get accustomed to your camera before taking important photographs.
- The screen and camera illustrations shown in this manual were produced during the development stages and may differ from the actual product.
- If there are additions and/or modifications of functions due to firmware update for the camera, the contents will differ. For the latest information, please visit the Olympus website or contact your Olympus Consumer Support Team in your region.

Unpack the box contents

The following items are included with the camera.

If anything is missing or damaged, contact the dealer from whom you purchased the camera.



Digital camera



Strap



Lithium Ion Battery
(LI-92B)

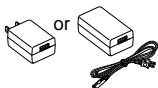

USB-AC adapter (F-5AC)



USB cable (CB-USB12)

Other accessories not shown: Warranty card
Contents may vary depending on purchase location.

Attaching the camera strap

1



2

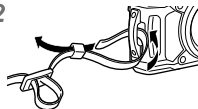

3

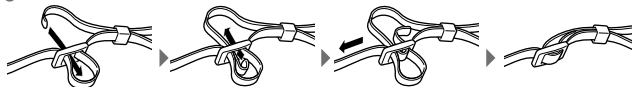

- Pull the strap tight so that it does not come loose.

Names of parts

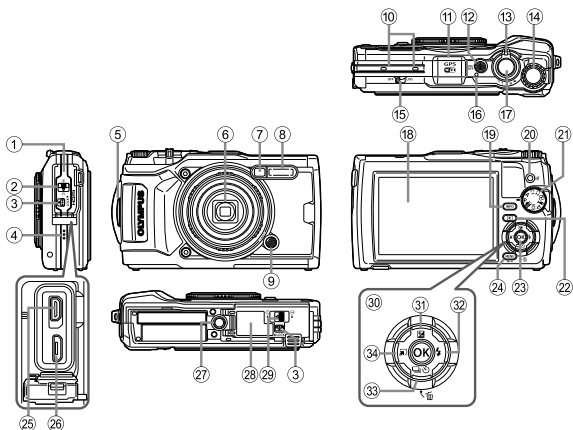

- ① Connector cover
- ② Connector cover lock
- ③ LOCK knob
- ④ Speaker
- ⑤ Strap eyelet
- ⑥ Lens
- ⑦ Self-timer lamp/LED Illuminator/ AF illuminator
- ⑧ Flash
- ⑨ Lens ring release button
- ⑩ Stereo microphone
- ⑪ GPS antenna
- ⑫ **ON/OFF** button
- ⑬ Zoom lever
- ⑭ Control dial
- ⑮ LOG switch
- ⑯ Indicator lamp
- ⑰ Shutter button
- ⑱ **INFO** (Information display) button
- ⑲ **INFO** (Information display) button
- ⑳ **◉** (Movie)/select button
- ㉑ Mode dial
- ㉒ **▶** (Playback) button
- ㉓ **OK** button
- ㉔ **MENU/Wi-Fi** button
- ㉕ HDMI micro connector
- ㉖ Micro-USB connector
- ㉗ Tripod socket
- ㉘ Battery/card compartment cover
- ㉙ Battery/card compartment cover lock
- ㉚ Arrow pad
- ㉛ **▲** (Up) / **☒** (Exposure compensation) button
- ㉜ **▶** (Right) / **⚡** (Flash) button
- ㉝ **▼** (Down) / **📷** (Sequential shooting/ Self-timer) / **🗑️** (Erase) button
- ㉞ **◀** (Left)/mode function button

• **▲ ▼ ◀ ▶** instruct to press the up/down/left/right arrow pad.

Preparations for shooting

Inserting and removing the battery and card

- 1** Follow Steps ①, ② and ③ to open the battery/card compartment cover.

- Turn off the camera before opening the battery/card compartment cover.

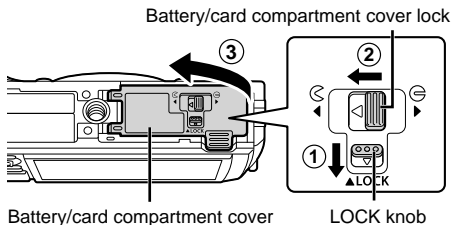

- 2** Insert the battery while sliding the battery lock knob in the direction of the arrow.

- Insert the battery as illustrated with the \ominus mark toward the battery lock knob.
- If you insert the battery in the wrong direction, the camera is not turned on. Be sure to insert it in the correct direction.
- Slide the battery lock knob in the direction of the arrow to unlock, and then remove the battery.

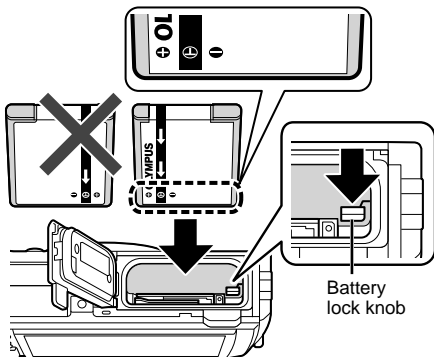

3 Insert the card straight until it clicks into place.

- Do not touch the metallic parts of the card directly.
- Always use the specified cards with this camera. Do not insert other types of memory cards.

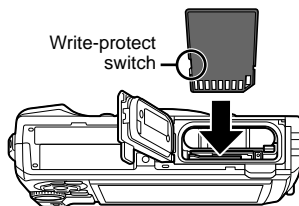

Cards compatible with this camera

SD/SDHC/SDXC/Eye-Fi (with Wireless LAN function) card (commercially available) (for compatibility card details, visit the Olympus website.)

To remove the card

Press the card in until it clicks and comes out slightly, then remove the card.

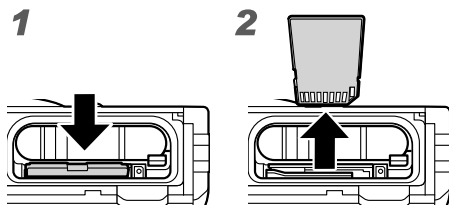

4 Follow Steps ①, ② and ③ to close battery/card compartment cover.

- When using the camera, be sure to close the battery/card compartment cover.

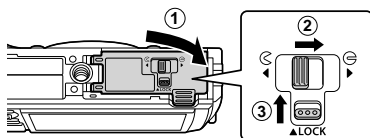

Charging the battery

1 Check that the battery is in the camera, and connect the USB cable and USB-AC adapter.

- The battery is not fully charged at shipment. Before use, be sure to charge the battery until the indicator lamp turns off (up to 3 hours).

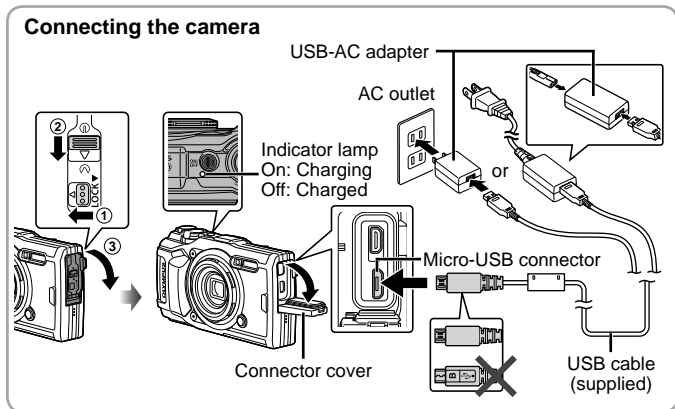

2 A menu will be displayed; highlight [Charge] and press the \odot button.

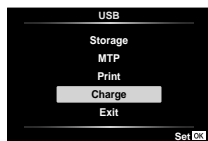

For charging the battery abroad, see “Using your charger and USB-AC adapter abroad” (P. 100).

- Never use any cable other than supplied or Olympus-designated USB cable. This may cause smoking or burning.
- The included F-5AC USB-AC adapter (hereafter referred to as USB-AC adapter) differs depending on the region where you purchased the camera. If you received a plug-in type USB-AC adapter, plug it directly into AC outlet.
- Be sure to unplug the power plug of the USB-AC adapter from the wall outlet when the charging is complete.

- For details on the battery, see “SAFETY PRECAUTIONS” (P. 120). For details on the USB-AC adapter, see “SAFETY PRECAUTIONS” (P. 120).
- If the indicator lamp does not light, reconnect the USB cable and USB-AC adapter to the camera.
- If the message “No Connection” is displayed in the monitor, disconnect and reconnect the cable.

When to charge the batteries

Charge the battery when the error message shown on the right appears.

Flashes in red



Error message

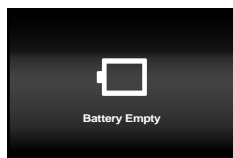

Turning on the camera and making the initial settings

When you turn on the camera for the first time, a screen appears enabling to set the language for the menus and messages displayed in the monitor, and the date and time.

To change the selected date and time, see “Setting the clock manually, choosing a time zone, and using GPS to set the clock” (P. 70)

- 1 Press the **ON/OFF** button to turn the camera on, highlight your language using $\Delta \nabla \triangleleft \triangleright$ (arrow pad) or the control dial, and press the **OK** button.

- In the case that the power is not turned on when you press the **ON/OFF** button, check the direction of the battery.  “Inserting and removing the battery and card” (P. 4)

- 2 Use $\Delta \nabla$ (arrow pad) or the control dial to select the year ([Y]).

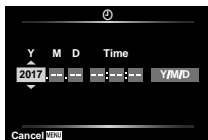

- 3 Press \triangleright (arrow pad) to save the setting for [Y].

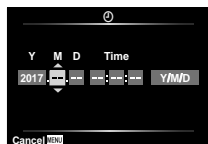

- 4 Select the month ([M]), day ([D]), hour and minute ([Time]), and the date display order ([Y/M/D]) using $\Delta \nabla \triangleleft \triangleright$ (arrow pad) as described in Steps 2 and 3, and then press the **OK** button.

- 5 Use $\Delta \nabla$ (arrow pad) to select the time zone and then press the **OK** button.

- Daylight saving time can be turned on or off using the **INFO** button.



Using basic functions

Taking photographs (P mode)

- 1** Press the **ON/OFF** button to turn on the camera.

When the camera is turned on, the monitor will turn on.

- 2** Set the mode dial to **P**.

In mode **P**, the camera automatically adjusts shutter speed and aperture in response to subject brightness.

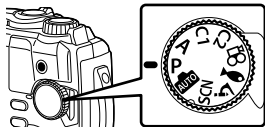

- 3** Frame the shot.

- When holding the camera, take care not to cover the flash, microphone or other important parts with your fingers, etc.

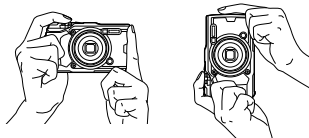

- 4** Press the shutter button halfway down to focus.

The focus indicator will blink to show that the camera is not in focus. Focus again.

- The shutter speed and aperture displays will blink to show that the camera is unable to achieve optimal exposure.

Press halfway



Focus indicator



Shutter speed value
Aperture value

- 5** To take the picture, gently press the shutter button all the way down while being careful not to shake the camera.

Press halfway





Press the rest of the way down



Viewing photographs (Playing back images)

Turn on the camera.

Press the  button.

- Your most recent photograph is displayed.
- Press   (arrow pad) or rotate the control dial to view other pictures.

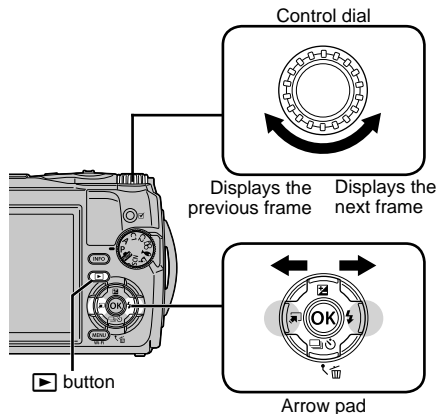





Still image

Index display/Calendar display

- To switch from single-frame to index playback, rotate the zoom lever counterclockwise. Repeating the process will increase the number of images displayed, ending in a calendar display.

  [Settings] (P. 62)

- Use     (arrow pad) or the control dial to move the cursor.
- Rotate the zoom lever clockwise to proceed in turn from calendar to index to single-frame playback.

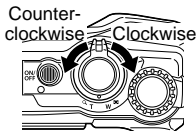

Close-up playback



- In single-frame playback, you can zoom in or out using the zoom lever: rotate the lever clockwise to zoom in from 2x to 14x and counterclockwise to zoom out. Press the **OK** button to return to single-frame playback.
- Press **△ ▽ ◀ ▶** (arrow pad) to scroll an image to the direction of the button you pressed.
- To view other images at the same zoom ratio, press the **INFO** button and then press **◀ ▶** (arrow pad). Press the **INFO** button again to re-enable scrolling. You can also view other images using the control dial.







Selecting Multiple Images

You can select multiple images for [5] (P. 13), [Erase Selected] (P. 16), and [Share Order Selected] (P. 13) operations. Press the **Ⓜ** (movie) button to select the image currently displayed during playback or highlighted in the index display (P. 10). Selected images are indicated by a **✓** icon. Press the button again to deselect the image.

Using the Playback Menu

The playback menu can be displayed by pressing the  button during playback. Highlight the desired option and select it by pressing the  button. The options displayed vary with the type of image selected.

Available Options

	RAW	JPEG	RAW+JPEG	Movies
Play 	✓	✓	✓	—
RAW Data Edit	✓	—	✓	—
JPEG Edit	—	✓	✓	—
Play Movie	—	—	—	✓
Movie Edit	—	—	—	✓
Share Order	—	✓	✓	✓
	✓	✓	✓	✓
	✓	✓	✓	—
Rotate	✓	✓	✓	—
	✓	✓	✓	✓
Image Overlay	✓	—	✓	—
	—	✓	✓	—
Erase	✓	✓	✓	✓

Play

Voice memos (P. 13) are played back when the associated image is displayed. Volume can be adjusted using Δ ∇ (arrow pad). Press **MENU** or  to end voice memo playback.

RAW Data Edit

Creates a JPEG copy of a RAW image according to the selected settings.

 [RAW Data Edit] (P. 57)

JPEG Edit

Edit JPEG images.  [JPEG Edit] (P. 57)



Play Movie

View the current movie.  “Movie playback” (P. 15)



Movie Edit

Edit movies.  [In-Movie Image Capture (Movie Edit)] (P. 59), [Movie Trimming (Movie Edit)] (P. 59)



Share Order

Select images for later transfer to a smartphone. You can also view the images currently selected for transfer. Press $\Delta \nabla$ (arrow pad) to select images for transfer. Selected images are indicated by a  icon; to deselect, press $\Delta \nabla$ (arrow pad) again. You can also select multiple images and then mark them all for transfer simultaneously.  "Selecting Multiple Images" (P. 11), "Transferring images to a smartphone" (P. 74)



Protect images from accidental deletion. Pressing $\Delta \nabla$ (arrow pad) marks images with a  (protect) icon. Press $\Delta \nabla$ (arrow pad) again to remove protection. You can also select multiple images and then protect them simultaneously.  "Selecting Multiple Images" (P. 11)



Audio can be added to still images (up to 30 sec. long).  [] (P. 59)

Rotate

Rotate the current image. The image rotates each time you press $\Delta \nabla$ (arrow pad); press the  button to complete the operation.

- The rotated image is saved in its current orientation.
- Movies and protected images cannot be rotated.



This function displays images stored on the card one after another.

 [] (P. 56)

Image Overlay

Up to 3 frames of RAW images taken with the camera can be overlaid and saved as a separate image.  [Image overlay] (P. 60)



Choose print options (the number of copies and date imprinting) for the images on the memory card.  "Print reservation (DPOF)" (P. 86)

Erase



Delete the current image.  "Erasing images during playback" (P. 16)

Recording movies



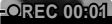

1 Press the (movie) button to start recording.

- The movie is shot in the set shooting mode. Note that the shooting mode effects may not be obtained for some shooting modes.
- Sound is also recorded.
- When using a camera with a CMOS image sensor, moving objects may appear distorted due to the rolling shutter phenomenon. This is a physical phenomenon whereby distortion occurs in the filmed image when shooting a fast-moving subject or due to camera shaking. In particular, this phenomenon becomes more noticeable when using a long focal length.



Recording time — 
Recording length — 

2 Press the (movie) button again to stop recording.

- When recording movies, use an SD card that supports an SD speed class of 10 or higher.
- Use a UHS-I card with a UHS speed class of 3 or better if:
[4K] or [High-speed] is selected for  (movie mode)/[Super Fine] is selected for bit rate
- When the mode dial is rotated to , you can choose sub modes for recording 4K or high-speed movies.  “ (movie mode)” (P. 25)

Movie playback

Pressing the **OK** button when a movie is selected in single-frame playback displays the playback menu. Highlight [Play Movie] and press the **OK** button to start movie playback.



Operations During Playback

Pause	Press the OK button to pause playback. To resume playback, press the OK button again.
Fast forward	Press ▶ (arrow pad) to fast forward. Press ▶ (arrow pad) again to increase the fast forward speed.
Rewind	Press ◀ (arrow pad) to rewind. Press ◀ (arrow pad) again to increase the rewind speed.
Adjusting the volume	Use △ ▽ (arrow pad) to adjust the volume.

Operations while playback is paused

Cueing	Use △ (arrow pad) to display the first frame and press ▽ to display the last frame.
Advancing and rewinding one frame at a time	Use ◀▶ (arrow pad) or the control dial to advance or rewind one frame at a time. Keep ◀▶ (arrow pad) pressed for continuous advance or rewind.
Resuming playback	Press the OK button to resume playback.

To stop movie playback

Press the **MENU** button.

- We recommend using OLYMPUS Viewer 3 (P. 90) to view movies on a computer. Be sure to use the latest version. Connect the camera to the computer before launching OLYMPUS Viewer 3 for the first time.

Erasing images during playback

1 Display the image you want to erase and press .

- To erase a movie, select the movie to erase and press .



2 Press $\Delta \nabla$ (arrow pad) to select [Yes], and press the  button.

- Grouped images are erased as a group (P. 11).
- Multiple images or all images can be erased at a time (P. 70).

Scrolling Panoramas

Panoramas made up of multiple images joined together can be viewed in a scrolling display.

1 Select a panorama in single-frame playback.

2 Rotate the zoom lever clockwise.

- Press $\Delta \nabla \triangleleft \triangleright$ (arrow pad) to scroll the image in the direction of the pressed button.
- During playback, you can rotate the zoom lever clockwise to zoom in from 2x to 14x or counterclockwise to zoom out. Press the  button to return to single-frame playback.
- To view other images at the same zoom ratio, press the **INFO** button and then press $\triangleleft \triangleright$ (arrow pad). Press the **INFO** button again to re-enable scrolling. You can also view other images using the control dial.



Viewing area

Monitor display

Shooting screen displays

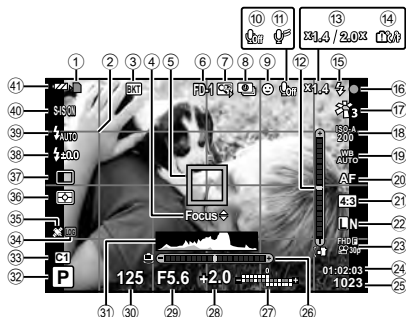

No.	Name
①	Card write indicator
②	Grid Guide
③	Bracketing icon
④	AF fine-tuning guide
⑤	AF target mark
⑥	Accessory
⑦	Digital zoom ratio* ¹
⑧	Time lapse shooting
⑨	Face priority
⑩	Movie sound
⑪	Wind noise reduction
⑫	Attitude indicator (pitch)
⑬	Optical zoom ratio/ magnification* ¹
⑭	Internal temperature warning
⑮	Flash (blinks: charging in progress, lights up: charging completed)
⑯	Focus indicator

No.	Name
⑰	Picture Mode
⑱	ISO sensitivity
⑲	White balance
⑳	AF mode
㉑	Aspect
㉒	Image quality (still images)
㉓	Record mode (movies)
㉔	Movie recording length
㉕	Number of storable still pictures
㉖	Attitude indicator (roll)
㉗	Top: Flash intensity control Bottom: Exposure compensation
㉘	Exposure compensation
㉙	Aperture value
㉚	Shutter speed
㉛	Histogram
㉜	Shooting mode

*1 Displayed at all times if [Microscope Control] (P. 27) is in use.

No.	Name
③③	Custom mode
③④	LOG icon/warning
③⑤	GPS icon
③⑥	Metering
③⑦	□/☺/Pro Capture shooting
③⑧	Flash Compensation
③⑨	Flash mode
④①	Image stabilization
④①	Battery check

Reading a histogram

If the peak fills too much of the frame, the image will appear mostly black.

If the peak fills too much of the frame, the image will appear mostly white.



The green section shows luminance distribution within the screen's center.

Switching the displays

Press the **INFO** button to cycle through the displays as follows: Basic Information*1, Image Only, Histogram Display (Custom1), Attitude Indicator (Custom2).

- You can change Custom1 and Custom2 settings. [Info Settings] > [LV-INFO] (P. 62)
- Hold the **INFO** button and rotate the control dial to rotate the shooting information display.

*1 Not displayed in mode (movie mode) unless recording is in progress.

The Attitude Indicator

The attitude indicator shows the amount of camera tilt. The vertical bar shows pitch, and the horizontal bar shows roll.

- The indicator is intended as a guide only.
- Error in the display can be corrected via calibration (P. 69).

Playback mode display

Switching the displays

Press the **INFO** button to cycle through the displays as follows: Simplified, Overall, Image Only.

- Histogram and highlight/shadow displays can be added to the playback information display. [/Info Settings] > [Info] (P. 62)

Simplified display

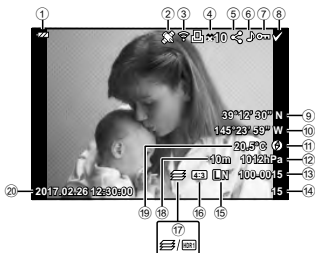

Overall display

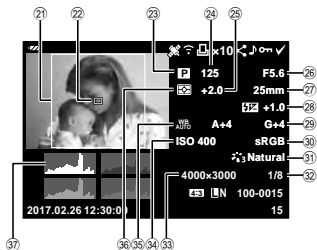
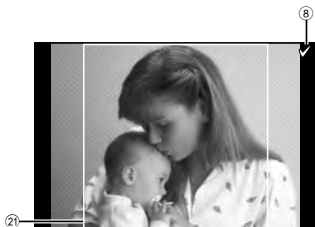

Image only



No.	Name	*1	*2	*3
①	Battery check	✓	✓	–
②	Including GPS information	✓	✓	–
③	Eye-Fi transfer data/Wi-Fi	✓	✓	–
④	Print reservation/ number of prints	✓	✓	–
⑤	Share order	✓	✓	–
⑥	Adding sound	✓	✓	–
⑦	Protect	✓	✓	–
⑧	Image selected	✓	✓	✓
⑨	Latitude	✓	–	–
⑩	Longitude	✓	–	–
⑪	Direction information	✓	–	–
⑫	Atmospheric	✓	–	–
⑬	File number	✓	✓	–
⑭	Frame number	✓	✓	–
⑮	Image quality	✓	✓	–
⑯	Aspect ratio	✓	✓	–
⑰	Focus Stacking/ HDR image	✓	✓	–
⑱	Altitude/Water depth	✓	–	–
⑲	Temperature (water temperature)	✓	–	–

No.	Name	*1	*2	*3
⑳	Recording date and time	✓	✓	–
㉑	Aspect border*4	✓	✓	✓
㉒	AF area pointer	–	✓	–
㉓	Shooting mode	–	✓	–
㉔	Shutter speed	–	✓	–
㉕	Exposure compensation	–	✓	–
㉖	Aperture value	–	✓	–
㉗	Focal length	–	✓	–
㉘	Flash intensity control	–	✓	–
㉙	White balance compensation	–	✓	–
㉚	Color space	–	✓	–
㉛	Picture mode	–	✓	–
㉜	Compression rate	–	✓	–
㉝	Image size	–	✓	–
㉞	ISO sensitivity	–	✓	–
㉟	White balance	–	✓	–
㊱	Metering mode	–	✓	–
㊲	Histogram	–	✓	–

*1 Simplified display

*2 Overall display

*3 Image only

*4 Displayed only if an aspect ratio other than 4:3 is selected with a RAW image quality option.

Shooting using basic functions

Using the shooting modes





Selecting shooting mode



Turn the mode dial to set the shooting mode to the indicator.

- After selecting **SCN**, , , or , select the sub mode.



List of shooting mode

 (iAUTO mode).....P. 21	SCN (Scene Mode)P. 22
P (Program mode)P. 9	 (movie mode)P. 25
A (A mode)P. 22	 (Underwater mode)P. 26
C1 (Custom mode 1).....P. 22	 (Microscope mode).....P. 27
C2 (Custom mode 2).....P. 22	

- Some features may be unavailable depending on the shooting mode and camera settings.  “List of settings available in each shooting mode” (P. 111), “List of  settings” (P. 112), “List of **SCN** settings” (P. 114), “List of  settings” (P. 113)
- In certain shooting modes, the camera may take a few moments for image processing after taking a picture.

(iAUTO mode)

A full auto mode in which the camera automatically optimizes settings for the current scene. The camera does all the work, which is convenient for beginners.

- 1 Rotate the mode dial to .
- 2 Press the shutter button halfway down to focus.
The focus indicator will blink to show that the camera is not in focus. Focus again.
- 3 Press the shutter button all the way down to shoot.

A (A mode)

When an aperture value is set, the camera automatically sets an appropriate shutter speed. You can change the aperture by rotating the control dial or by pressing Δ and then $\Delta \nabla$ (arrow pad).









C1/C2 (Custom mode)













If you store shooting settings in [Reset/Assign Custom Modes] (P. 52), you can call up and shoot using the stored shooting settings.

- You can register different settings in C1 and C2.

SCN (scene mode)

Only by selecting a sub mode according to the subject or the scene, you can shoot with an proper setting.

Sub mode 1	Sub mode 2	Application
People	 Portrait	Suitable for portrait shooting.
	 e-Portrait	Smooths out skin tones and texture. This mode is suitable when viewing images on a high-definition TV.
	 Portrait + Landscape	Suitable for portraits featuring a landscape in the background.
	 Portrait + Nightscape	Suitable for portrait shooting against a background of night view.
	 Children	Suitable for photographs of children and other active subjects.
Nightscapes	 Nightscape	Suitable for tripod shooting of night scenes.
	 Portrait + Nightscape	Suitable for portrait shooting against a background of night view.
	 Handheld Starlight	Suitable for shooting night scenes without a tripod. Reduces blur when shooting low light/illuminated scenes.
	 Fireworks	Suitable for shooting fireworks at night.

Sub mode 1	Sub mode 2	Application
Nightscapes	 Live Composite	The camera automatically shoots multiple images, takes newly bright areas only, and composites them into a single image. With normal long exposure, an image of light trace such as star trails with bright buildings tends to get too bright. You can capture them without over exposure while checking the progress.
Motion	 Sport	Suitable for fast action shooting.
	 Children	Suitable for photographs of children and other active subjects.
Scenery	 Landscape	Suitable for landscape shooting.
	 Sunset	Suitable for shooting the sunset.
	 Beach & Snow	Suitable for shooting at snow-capped mountains, seascapes in the sun, and other whitish scenes.
	 Panorama	You can shoot and combine multiple images to create an image with a wide angle of view (panoramic image).
	 Backlight HDR	Suitable for contrasting scenes. This mode captures multiple images and merges them into one, properly exposed image.
Indoors	 Candlelight	Suitable for shots of candlelit scenes. Warm colors are preserved.
	 Portrait	Suitable for portrait shooting.
	 e-Portrait	Smooths out skin tones and texture. This mode is suitable when viewing images on a high-definition TV.
	 Children	Suitable for photographs of children and other active subjects.
	 Backlight HDR	Suitable for contrasting scenes. This mode captures multiple images and merges them into one, properly exposed image.

- 1 Rotate the mode dial to **SCN**.
- 2 Use $\Delta \nabla \triangleleft \triangleright$ (arrow pad) or the control dial to highlight an option for sub mode 1 and press the OK button to select.

Sub mode 1



- 3 Use $\triangleleft \triangleright$ (arrow pad) or the control dial to highlight an option for sub mode 2 and press the OK button to select.

Sub mode 2



- Press the **MENU** button to return to the sub mode 1 display.

- When the mode dial is rotated to **SCN**, the sub mode 1 display can be viewed by pressing \triangleleft (arrow pad).
- The live control (P. 34) can also be used to select sub mode 2.

Live Composite

- ① Press the shutter button halfway down to focus.
 - Mount the camera securely on a tripod to reduce blur caused by camera shake.
 - If the focus indicator blinks, the camera is not in focus. When the focus indicator is flashing, you can focus at infinity by pressing the OK button while the shutter button is pressed halfway.
- ② To take the picture, gently press the shutter button all the way down while being careful not to shake the camera.
 - The camera configures the proper settings automatically and starts shooting.
 - After pressing the shutter button, there is a time lag until shooting starts.
 - A combined panorama image is displayed per certain period of time.
- ③ Press the shutter button again to stop shooting.
 - The recording length in one shooting is up to three hours.

Panorama

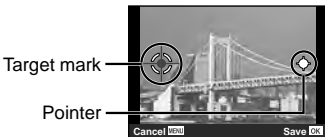

- 1 Press the shutter button to take the first frame.
- 2 Pan the camera slowly to frame the second shot.
 - A target mark will be displayed.
- 3 Move the camera slowly so that the pointer and the target mark overlap. The camera releases the shutter automatically when the pointer and the target overlap.
 - To combine only two frames, press the **OK** button.
- 4 Repeat step 3 to take a third frame. The camera automatically combines the frames into a single panorama image.
 - To cancel the panorama function, press the **MENU** button.





Screen when combining images from left to right

(movie mode)

In addition to normal footage, you can record high-resolution 4K movies or shoot high-speed movies that play back in slow motion.

Sub mode	Application
 Standard	Record normal movies.
 4K	Record high-definition 4K movies.
 HS	Record fast-moving subjects for slow-motion playback.

- 1 Rotate the mode dial to .
- 2 Use  (arrow pad) or the control dial to highlight a sub mode and press the **OK** button to select.











- 3 Press the  (movie) button to start recording.
 - To end recording, press the  (movie) button again.
- When the mode dial is rotated to , the sub mode display can be viewed by pressing .

Image Quality



You can adjust image quality using live controls.  "Record mode (movies)" (P. 39)

(Underwater mode)

Only by selecting a sub mode according to the subject or the scene, you can shoot underwater photographs with a proper setting.



Sub mode	Application
 Underwater Snapshot	Optimized for underwater photography that uses natural light.
 Underwater Wide	Suitable for shooting underwater.
 Underwater Macro	Suitable for shooting close-up view underwater.
 Underwater HDR	Suitable for contrasting underwater scenes. This mode captures multiple images and merges them into one, properly exposed image. This mode may not function well for shooting a fast-moving subject.

1 Rotate the mode dial to .

2 Use   (arrow pad) or the control dial to highlight a sub mode and press the  button to select.



3 Press the shutter button all the way down to take the picture.

- To take a series of shots at the same focus distance, use AFL (P. 32) or MF (P. 37).
- When the mode dial is rotated to , the sub mode display can be viewed by pressing  (arrow pad).

🔍 (Microscope mode)

Images can be taken from up to 1 cm away from the subject. In this mode you can shoot images with a large depth of field, and perform focus bracket shooting of a set number of images.

- 1 Rotate the mode dial to 🔍.
- 2 Use ◀▶ (arrow pad) or the control dial to highlight a sub mode and press the (OK) button to select.



Sub mode	Application
Microscope	Images can be taken from up to 1 cm away from the subject.
Focus Stacking*1	The camera shoots a number of images, automatically shifting the focus in each image. These can then be combined into a composite image with a large depth of field. Two images are recorded, the first frame and the composite image.
Focus Bracketing	In this mode, the camera shoots a number of images, automatically shifting the focus in each image. The number of images and shooting steps are set in [Focus BKT] (P. 55).
Microscope Control	Optimized for close-ups with the subject magnified in the monitor. The magnification level when the shooting distance is 1 cm is displayed on the monitor. Pressing ▶ (arrow pad) can change the magnification level. At high magnification levels, the image may be grainy.

*1 There may be situations in which it is not possible to create composite image due to camera shake.

- 3 Press the shutter button all the way down to shoot.
 - To take a series of shots at the same focus distance, use AFL (P. 32) or MF (P. 37).
 - When the mode dial is rotated to 🔍, the sub mode display can be viewed by pressing ◀ (arrow pad).

Using the zoom

Zoom in to photograph distant objects or zoom out to increase the area visible in the frame. Zoom can be adjusted using the zoom lever.

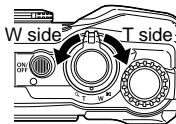

Using shooting options (Set by direct button)

Frequently used functions are assigned to $\triangleright \triangle \nabla$ (arrow pad). Just by pressing the button, you can select the assigned function directly.



Some features may be unavailable depending on the shooting mode and camera settings. "List of settings available in each shooting mode" (P. 111)



Flash

You can use a flash when shooting.

- 1 Press the button to display options.
- 2 Use $\triangleleft \triangleright$ (arrow pad) or the control dial to highlight a flash mode and press the button to select.

AUTO Flash Auto	The flash fires automatically in low light or backlight conditions.
Fill In	The flash fires regardless of the light conditions.
Redeye	This function allows you to reduce the red-eye phenomenon.
Flash Off	The flash does not fire.
Red-Eye Slow	Combines slow sync with red-eye reduction.
SLOW SLOW	Slow shutter speeds are used to brighten dimly-lit backgrounds.

 Manual	Control flash output manually. If you highlight "Manual" and press the INFO button before pressing the OK button, you can adjust flash output using Δ ∇ $\langle \rangle$ (arrow pad) or the control dial.
 Remote Control	The dedicated underwater strobe or the Olympus wireless RC flash is used to take pictures. For details, see "Taking pictures with the Olympus Wireless RC Flash System" (P. 105).
 LED On	The LED turns on when a picture is taken. This is effective for taking close up pictures.

- In [, after the pre-flashes, it takes about 1 second before the shutter is released. Do not move the camera until shooting is complete.
- [] may not work effectively under some shooting conditions.
- The shutter speed becomes slower in [ SLOW]. Use a tripod and secure the camera.
- Some features may be unavailable depending on the shooting mode and camera settings.

Exposure compensation

Compensates the brightness (appropriate exposure) adjusted by the camera.

1 Rotate the control dial, or press the  button and use $\langle \rangle$ (arrow pad).

- Depending on the shooting mode and camera settings, you may not be able to adjust exposure compensation using the control dial.
- Choose positive ("+" values to make pictures brighter, negative ("–") values to make pictures darker.

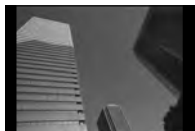

Negative (–)





No compensation (0)













Positive (+)

Single/Sequential

Hold the shutter-release button all the way down to take a series of photographs.

- 1 Press the  button to display the direct menu.
- 2 Press  (arrow pad) or rotate the control dial to highlight an option and then press the  button.

 Single	Shoots 1 frame at a time when the shutter button is pressed (normal shooting mode).
 Sequential High	Hold the shutter-release button all the way down to take a series of photographs. <ul style="list-style-type: none">• To choose a frame advance rate, highlight [Sequential High] and press the INFO button before you press the  button. Choose from frame advance rates of approximately 10 frames per second (10 fps) or 20 frames per second (20 fps). Use     (arrow pad) or the control dial to highlight a frame advance rate and press the  button to select.
 Sequential Low	Pictures will be taken at about 5 fps while the shutter button is pressed all the way down.
 Pro Capture	Sequential shooting begins when you press the shutter button halfway. Press the shutter button all the way down to begin recording captured images to the card, including those for a halfway press.  "Pro Capture" (P. 31)

- During sequential and Pro Capture shooting, focus, exposure, and white balance are fixed at the values for the first shot.
- During sequential shooting, if the battery check blinks due to low battery, the camera stops shooting and starts saving the pictures you have taken on the card. The camera may not save all of the pictures depending on how much battery power remains.

Pro Capture

To eliminate the lag between the shutter button being pressed all the way down and the start of recording, the camera starts shooting a series of pictures using the electronic shutter when the shutter button is pressed halfway, and begins recording the pictures—including those taken when the shutter button was pressed halfway (up to 4)—to the card when the shutter button is pressed the rest of the way down.

- 1 Press the button.
- 2 Press (arrow pad) or rotate the control dial to highlight [] (Pro Capture) and then press the button.
- 3 Press the shutter button halfway to start shooting.
- 4 Press the shutter button all the way down to start recording to the card.
 - Pro Capture shooting is not available when connected to Wi-Fi.
 - The camera will continue shooting for up to a minute while the shutter button is pressed halfway. To resume shooting, press the button halfway again.
 - Flickering occurred by fluorescent lights or the large movement of the subject, etc. may cause distortions in images.
 - The monitor will not be blacked out and the shutter sound will not be emitted while bracketing.
 - The slowest shutter speed is limited.

Self timer

Sets the time after the shutter button is pressed until the picture is taken.

- 1 Press the button to display the direct menu.
- 2 Press (arrow pad) or rotate the control dial to highlight [], [], or [] and then press the button.

12 12 sec	Press the shutter button halfway to focus, the rest of the way down to start the timer. First, the self-timer lamp lights up for approximately 10 seconds, then it blinks for approximately 2 seconds and the picture is taken.
2 2 sec	Press the shutter button halfway to focus, the rest of the way down to start the timer. The self-timer lamp blinks for approximately 2 seconds, and then the picture is taken.
Custom Self-timer	After selecting this mode, press the INFO button to set “the time from pressing the shutter button until the picture is taken, the number of frames, and the interval time”. Pictures are taken by these setting.

- To cancel the activated self-timer, press the **MENU** button.
- Self timer is not canceled automatically after shooting.

AFL (Focus lock)

You can lock the focus position.

- 1 Press the shutter button halfway to focus.
- 2 While keeping the position of the camera, press the **OK** button.

The camera focuses and locks the position.

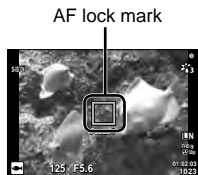

- While focus lock is in effect, the focus distance can be fine-tuned using Δ ∇ (arrow pad) or the control dial.
- Pressing the **OK** button, zooming operation, pressing the **MENU** button, and the other operations also release the focus lock.
- If the focus indicator blinks when the shutter button is pressed halfway with [**Live Composite**] (P. 24) selected for **SCN** mode, you can set focus to infinity by pressing the **OK** button.
- AFL is not available in **AUTO** mode and some **SCN** modes.

Area

You can select the position of the AF target mark manually.



Before proceeding, select [**[]**] for [AF Area] in Shooting Menu 1 (P. 53).

- 1 Press and hold the **OK** button.
- 2 Use Δ ∇ \triangleleft \triangleright (arrow pad) to select the position of AF target mark and press the **OK** button.
 - Pressing and holding the **OK** button before setting the position returns the AF target mark to the center.

AF Tracking

The camera tracks the subject movement automatically to focus on it continuously.



Before proceeding, select [Tracking] for [AF Area] in Shooting Menu 1 (P. 53).



- 1** Place the AF target mark over your subject and press the  button, keeping the shutter button pressed halfway.
- 2** When the camera recognizes the subject, the AF target mark automatically tracks the subject movement to focus on it continuously.
 - To cancel the tracking, press the  button.
 - Depending on the subjects or the shooting conditions, the camera may be unable to lock the focus or fail to track the subject movement.
 - When the camera fails to track the subject movement, the AF target mark changes to red.

Using shooting options (via live control)







Some features may be unavailable depending on the shooting mode and camera settings.  “List of settings available in each shooting mode” (P. 111)

Available Options

Picture Mode	P. 35	Image stabilizer (still images)*2..	P. 40
Scene mode	P. 22	Image stabilizer (movies)*1	P. 40
ISO sensitivity.....	P. 36	Flash*2*3	P. 41
White balance.....	P. 36	Flash Compensation*2	P. 41
AF mode.....	P. 37	 	P. 42
Aspect.....	P. 38	Metering mode*2.....	P. 42
Image quality (still images).....	P. 38	Face priority.....	P. 43
Record mode (movies)*1	P. 39	Accessory	P. 43







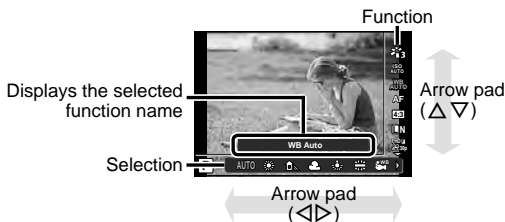



















- The selected setting applies in both **P** and **A** modes.
- *1 Displayed only in movie mode.
- *2 Not displayed in movie mode.
- *3 The camera stores the settings for **P**, **A**,  (underwater mode), and  (microscope mode) separately and restores them the next time the mode is selected, even after the camera has been turned off. The ISO sensitivity for  Underwater HDR is not restored, however.

Using Live Controls

- 1 Press the  button to display live controls.
 - To hide live controls, press the  button again.
- 2 Press   (arrow pad) to highlight the desired function, then use   (arrow pad) or the control dial to highlight an option and press the  button.
 - The highlighted option will be selected automatically if no operations are performed for about 8 seconds.



- The default settings of the function are highlighted in .

Picture Mode		Sets the processing options.
	i-Enhance	Produces more impressive-looking results suited to the scene.
	Vivid	Produces vivid colors.
	Natural	Produces natural colors.
	Muted	Produces flat tones.
	Portrait	Produces beautiful skin tones.
	Monochrome	Produces black and white tone.
	Custom	Use to select one picture mode, set the parameters, and register the setting.
	e-Portrait	Produces smooth skin textures. This mode cannot be used with bracket photography or when shooting movies.
ART 1  / ART*1 	Pop Art	Enhances the color and atmosphere of an image more brightly and vividly.
ART 2 	Soft Focus	Expresses an ethereal atmosphere with a soft tone and makes an image dreamy.
ART 3  / ART*1 	Pale&Light Color	Expresses a comfortable floating feeling by making an image more pale and light.
ART 4 	Light Tone	Creates a high-quality image by softening both shadows and highlights.
ART 5  / ART*1 	Grainy Film	Expresses the strength and roughness of black and white.
ART 6  / ART  / ART*1  / ART 	Pin Hole	Expresses the tunnel effect like that obtained from an old fashioned camera or a toy camera by reducing the peripheral brightness.
ART 7  / ART*1 	Diorama	Expresses an image shooting a surreal miniature world with enhancing the saturation and contrast and blurring an out-of-focus area of an image.
ART 8  / ART*1 	Cross Process	Creates an image that expresses a surreal atmosphere.
ART 9 	Gentle Sepia	Creates a high-quality image by drawing out shadows and softening the overall image.
ART 10  / ART*1 	Dramatic Tone	Enhances the local contrast of an image and provide an image that a difference of brightness and darkness is emphasized.







Picture Mode		Sets the processing options.
ART 11 / ART*1 11	Key Line	Creates an image that emphasizes edges and adds an illustrative style.
ART 12 / ART*1 12	Watercolor	Creates a soft, bright image by removing dark areas, blending pale colors on a white canvas, and further softening contours.
ART 13 / ART 13 / ART*1 13	Vintage	Expresses an everyday shot in a nostalgic, vintage tone using printed film discoloration and fading.
ART 14 / ART 14 / ART*1 14	Partial Color	Impressively expresses a subject by extracting colors you want to emphasize and keeping everything else monotone. Press the INFO button and then use the control dial to choose a color.

- When [ART] is selected for picture mode, [Color Space] (P. 66) will be locked at [sRGB].



*1 II and III are altered versions of the original (I).

ISO sensitivity		Sets the ISO sensitivity.
ISO AUTO	ISO Auto	The camera automatically sets the sensitivity with priority on image quality.
ISO 100 to ISO 12800	Value	Set a smaller value to reduce noise in the picture, or a larger value to reduce blur.

White balance		Sets an appropriate color scheme for the light of the shooting scene.
WB AUTO	WB Auto	The camera automatically adjusts the white balance.
	Sunny	Suitable for shooting outdoors under a clear sky.
	Shadow	Suitable for shots taken in the shade on sunny days.
	Cloudy	Suitable for shooting outdoors under a cloudy sky.
	Incandescent	Suitable for shooting under tungsten lighting.
	Fluorescent	Suitable for shooting under white fluorescent lighting.
	Underwater	Suitable for underwater shooting.
WB	WB Flash	Suitable for flash photography.

White balance		Sets an appropriate color scheme for the light of the shooting scene.
	One Touch 1	Suitable for situations such as: the other options do not produce the desired colors, you are unsure as to the type of light source, or the subject is lit by multiple different sources. For manually adjusting the white balance according to the light when shooting. Set a piece of white paper or other white object so that it fills the entire screen, and press the INFO button to set the white balance. For how to register one touch white balance, see "Registering one touch white balance" (P. 37).
	One Touch 2	
	One Touch 3	
	One Touch 4	
 Custom white balance		Press the INFO button, then highlight a color temperature using Δ ∇ (arrow pad) and press the  button. Choose from color temperatures of from 2000 to 14000K.

Registering one touch white balance

Select an option of from [ One Touch 1] to [ One Touch 4], then aim the camera at a white piece of paper or a similar subject and press the **INFO** button followed by the shutter button.

- The shutter will be released and you will be asked if you wish to keep the new value. Select [Yes] to keep the new value. Any previously-saved value will be replaced.
- The registered white balance data will not be cleared by turning off the power.
- Perform this procedure under the light where the pictures will be actually taken.
- When the camera settings are changed, the white balance must be registered again.

AF mode		Focusing method
AF	AF	The camera focuses automatically when the shutter button is pressed halfway. You can choose the focus area in the shooting menu. <ul style="list-style-type: none"> • The camera adjusts focus continuously during movie recording.
MF	MF	Use Δ ∇ (arrow pad) or the control dial to focus manually on a subject anywhere in the frame. Manual focus can be enabled by pressing and holding the  button during shooting.







Aspect	Settings	Sets the horizontal-to-vertical ratio of images.
 4:3	4:3	Change the horizontal-to-vertical ratio when taking pictures.
 16:9	16:9	
 3:2	3:2	
 1:1	1:1	
 3:4	3:4	























Image quality (still images)* ¹		Image quality options (photos)
RAW	RAW	Choose an image quality for photographs. Choose from JPEG and RAW * ² * ³ . Select JPEG+RAW * ⁴ to record each photograph twice, once in JPEG and once in RAW format. JPEG offers a choice of sizes (L, M, and S) and compression ratios (SF, F, N, and B). <ul style="list-style-type: none"> Image quality affects the number of pictures that can be stored on the memory card (P. 102).
L F	[L] F	
L N	[L] N	
M N	[M] N	
S N	[S] N	
L F+RAW	[L] F+RAW	
L N+RAW	[L] N+RAW	
M N+RAW	[M] N+RAW	
S N+RAW	[S] N+RAW	

*1 Only the default options are listed. To select options other than **L**F [L] F, **L**N [L] N, **M**N [M] N, and **S**N [S] N, use  Set (P. 65) in Custom Menu E.



*2 RAW: This format (extension “.ORF”) stores unprocessed image data for later processing. Using OLYMPUS Viewer 3 (P. 90), you can adjust settings such as exposure compensation and white balance or apply art filters. Be sure to use the latest version of OLYMPUS Viewer 3. General-purpose imaging software can not be used to view, edit, or print RAW images.

*3 Not available with , , , , , , and .

*4 The individual JPEG and RAW files recorded each time a photo is taken at a setting of JPEG+RAW can not be deleted separately. Deleting one automatically deletes the other (if you delete the JPEG copy on a computer and then copy the RAW image back to the camera, you will be able to edit the image (P. 12) but not select it for printing (P. 86)).

Record mode (movies)	Image quality options (movies)
[Standard] is selected for 	<p data-bbox="470 326 926 433">Choose the desired combination of frame size, bit rate, and frame rate. Bit rate and frame rate can be adjusted from the video menu (P. 55).</p> <div data-bbox="619 448 810 672" style="text-align: center;">  </div> <p data-bbox="470 693 806 914"> ① Frame size FHD : 1920×1080 HD : 1280×720 4K : 3840×2160 ② Bit rate (compression ratio) SF, S, F, N ③ Frame rate 30p (60p), 25p (50p) </p>
 1920×1080 Super Fine 60p	
 1920×1080 Super Fine 50p	
 1920×1080 Super Fine 30p	
 1920×1080 Super Fine 25p	
 1280×720 Super Fine 30p	
 1280×720 Super Fine 25p	
 1920×1080 Fine 60p	
 1920×1080 Fine 50p	
 1920×1080 Fine 30p	
 1920×1080 Fine 25p	
 1280×720 Fine 30p	
 1280×720 Fine 25p	
 1920×1080 Normal 60p	
 1920×1080 Normal 50p	
 1920×1080 Normal 30p	
 1920×1080 Normal 25p	
 1280×720 Normal 30p	
 1280×720 Normal 25p	
[4K] is selected for  *1	
 3840×2160 30p	
 3840×2160 25p	

*1 The bit rate can not be changed.















Record mode (movies)		Image quality options (movies)
[High-speed] is selected for  *2		<div style="text-align: center;"> ①  </div> <p>① Frame size FHD : 1920×1080 HD : 1280×720 SD : 640×360</p>
FHD HS 120fps	1920×1080 HighSpeed 120fps	
HD HS 240fps	1280×720 HighSpeed 240fps	
SD HS 480fps	640×360 HighSpeed 480fps	



*2 The frame rate and bit rate can not be changed.

Image stabilizer (still images)		Image stabilization options (photos)
OFF	OFF	Turn photo image stabilization on or off.
ON	ON	

Image stabilizer (movies)		Image stabilization options (movies)
OFF	OFF	Turn movie image stabilization on or off.
ON	ON*1	

*1 Defaults to [OFF] when [High-speed] is selected as the  sub-mode.

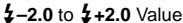

Flash		Sets the flash firing method.
 AUTO	Flash Auto	The flash fires automatically in low-light or backlight conditions.
	Fill In	The flash fires regardless of the available light.
	Redeye	Pre-flashes are emitted to reduce the occurrence of red eye in your photos.
	Flash Off	The flash does not fire.
 SLOW	Red-Eye Slow	Combines slow sync with red-eye reduction.
 SLOW	SLOW	Slow shutter speeds are used to brighten dimly-lit backgrounds.
 FULL	Manual	Control flash output manually. If you highlight "Manual" and press the INFO button before pressing the  button, you can adjust flash output using     (arrow pad) or the control dial.
 RC	Remote Control	The dedicated underwater strobe or the Olympus wireless RC flash is used to take pictures. For details, see "Taking pictures with the Olympus Wireless RC Flash System" (P. 105).
	LED On	The LED turns on when a picture is taken. This is effective for taking close up pictures.

Flash Compensation	Compensates the flash brightness (amount of flash) adjusted by the camera.
 -2.0 to +2.0 Value	<p>Adjust flash output. Flash brightness can be reduced by selecting negative values (the lower the value, the dimmer the flash) or increased by selecting positive values (the higher the value, the brighter the flash).</p> <ul style="list-style-type: none"> Not available in AUTO mode, when [ Underwater HDR] is selected in  mode, or in SCN mode.

		Sets the sequential shooting function and the time from pressing the shutter button until the picture is taken.
	Single	One frame is shot each time the shutter button is pressed.
	Sequential High	Hold the shutter-release button all the way down to take a series of photographs. <ul style="list-style-type: none"> To choose a frame advance rate, highlight [Sequential High] and press the INFO button before you press the button. Choose from frame advance rates of approximately 10 frames per second (10 fps) or 20 frames per second (20 fps). Use (arrow pad) or the control dial to highlight a frame advance rate and press the button to select.
	Sequential Low	Pictures will be taken at about 5 fps while the shutter button is pressed all the way down.
	12 sec	The self-timer lamp turns on for approx. 10 seconds, then blinks for approx. 2 seconds, and then the picture is taken.
	2 sec	The self-timer lamp blinks for approx. 2 seconds, then the picture is taken.
	Custom Self-timer	Photographs are taken at “the time from pressing the shutter button until the picture is taken, the number of frames, and the interval time” which you set.
	Pro Capture	Sequential shooting begins when you press the shutter button halfway. Press the shutter button all the way down to begin recording captured images to the card, including those for a halfway press. “Pro Capture” (P. 31)

Metering mode	Metered area
Spot	Shoots the subject at the center during backlighting (Meters the brightness at the center of the screen).
ESP	Shoots to obtain a balanced brightness over the entire screen (Meters the brightness at the center and surrounding areas of the screen separately). When set to [ESP], the center may appear dark when shooting against strong backlighting.

Face priority		Focus/exposure
ON	Face Priority On	When [Face Priority On] is selected, the camera will automatically detect and adjust focus and exposure for the faces of portrait subjects.
OFF	Face Priority Off	

Accessory		Settings for optional accessories
OFF	Accessory Off	Select when taking pictures without a conversion lens.
	PTWC-01	Select depending on designated optional conversion lenses.
	FCON-T01	
	TCON-T01	
FD-1	FD-1	Settings are optimized for flash photography with the FD-1 attached.

Recording and using logs (LOG mode)

While the LOG switch is in the **LOG** position, the camera will log GPS and other sensor data (P. 78). Logs can be downloaded for use with the OLYMPUS Image Track (OI.Track) smartphone app.

Recording and saving logs

Rotate the LOG switch to **LOG**.

- Logging will start. The indicator lamp will blink while logging is in progress.

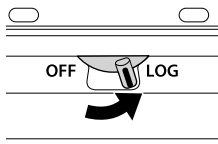

- Data acquisition and logging will end automatically when the battery runs low. Rotate the LOG switch to **OFF** to save the log.
- In LOG mode, the camera draws on the battery continuously to acquire location data.
- No data can be added to the log once the memory allocated to temporary log storage is full, in which case you will need to rotate the LOG switch to **OFF** to save the log to the memory card. 📖 “Log recording problems” (P. 95)

Saving logs

The current log is saved to the card when the LOG switch is rotated to **OFF**.

- A message is displayed in the monitor while the log is being saved. Do not remove the memory card until the message has cleared from the display. Removing the memory card while the log is being saved could cause loss of the log file or camera or memory card malfunction.
- The camera may not begin saving the log to the memory card when the LOG switch is rotated to **OFF** if, for example, wireless data transfer is in progress or the memory card is full or write-protected, in which case you should terminate wireless data transfer, delete unwanted data from the card, or otherwise enable the log to be saved. Do not remove the battery from the camera until the log has been saved.
 - The log will not be saved if no memory card is inserted.
- Each card can store up to 199 log files. An error message will be displayed when the log file count approaches this number (P. 93). Should this occur, insert another card or delete log files after copying them to a computer.
- Log files are recorded to the “GPSLOG” and “SNSLOG” folders on the card (P. 101).

Using buffered and saved logs

To access logs stored in the camera's temporary buffer or saved to the card, launch the OLYMPUS Image Track (OI.Track) smartphone app and connect to the smartphone using the camera wireless LAN function (P. 73).

Things you can do with the specified app, OLYMPUS Image Track (OI.Track)

- Viewing the current log and images
The current log and images can be viewed on the smartphone.
- Downloading the current log and images
The current log and images can be copied to and browsed on the smartphone.
- Viewing tracks
Logs stored on the card can be copied to the smartphone and viewed as tracks.
- Linking images to a log
Images shot while log recording was enabled can be linked to the log for viewing or file management.
- OI.Track can be used to update GPS assist data (P. 79).

For details, visit the address below:

<http://app.olympus-imaging.com/oitrack/>

Location data/LED Illuminator

Viewing location data

Pressing the **INFO** button when the camera is off displays location data in the monitor.

- The accuracy of the data displayed varies with weather conditions and the like. Use as a rough guide only.

Location data displays

No.	Name
1	Time
2	Log recording in progress
3	Direction information
4	Temperature (water temperature)
5	Atmospheric pressure
6	Altitude (depth)
7	GPS icon
8	Latitude
9	Longitude

Latitude and longitude

If the GPS icon blinks or is not displayed, the camera is unable to determine the current position.

GPS and other data displays

These displays are not intended for applications that require a high degree of precision, and the accuracy of the data (latitude and longitude, heading, depth, temperature, and the like) they provide is not guaranteed. The accuracy of these displays may be also affected by factors not under the control of the manufacturer.

Using the LED Illuminator

Press and hold the **INFO** button down until the LED illuminator lights up. The illuminator will light even if the camera is off.

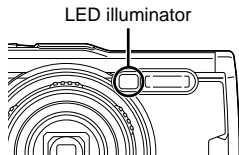

If the Camera Is On

The LED illuminator will remain lit for up to around 90 seconds while camera controls are in use, or up to 30 seconds if no operations are performed.

If the Camera Is Off

The LED illuminator will remain lit for up to around 30 seconds, whether or not you attempt to operate camera controls.

- The LED illuminator turns off automatically if you:
 - press the **ON/OFF** button,
 - use the LOG switch,
 - display the menus,
 - connect or disconnect a USB cable, or
 - connect to a Wi-Fi network.
- Location data can be displayed by pressing the **INFO** button (P. 46) even when the LED illuminator is lit.







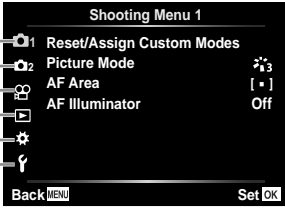

To turn the LED illuminator off





Press and hold the **INFO** button down until the LED illuminator turns off.

Using the menus

Menu List

 <p>Shooting Menu 1</p> <p>① Reset/Assign Custom Modes</p> <p>② Picture Mode [•]</p> <p>③ AF Area Off</p> <p>④ AF Illuminator</p> <p>⑤ </p> <p>⑥ </p> <p>Back Set </p>	<p>① Shooting Menu 1 (P. 52)</p> <p>Reset/Assign Custom Modes</p> <p>Picture Mode</p> <p>AF Area</p> <p>AF Illuminator</p>																																
<p>② Shooting Menu 2 (P. 54)</p> <p>Intrvl. Sh./Time Lapse</p> <p>Focus BKT</p>	<p>③ Video Menu (P. 55)</p> <p>Movie </p> <p>Recording Volume</p> <p>Video Frame Rate</p> <p>Video Bit Rate</p>																																
<p>④ Playback Menu (P. 56)</p> <table border="1" data-bbox="88 677 963 764"> <tbody> <tr> <td data-bbox="88 677 523 764"> Edit </td> <td data-bbox="528 677 963 764"> Print Order (P. 86) Reset Protect Connection to Smartphone </td> </tr> </tbody> </table>		 Edit	Print Order (P. 86) Reset Protect Connection to Smartphone																														
 Edit	Print Order (P. 86) Reset Protect Connection to Smartphone																																
<p>⑤ Custom Menu (P. 61)</p> <table border="1" data-bbox="88 822 963 1311"> <tbody> <tr> <td colspan="2" data-bbox="88 822 963 851">A. MF</td> </tr> <tr> <td data-bbox="88 851 155 880"></td> <td data-bbox="160 851 963 880">MF Assist</td> </tr> <tr> <td colspan="2" data-bbox="88 880 963 910">B1. Disp//PC</td> </tr> <tr> <td data-bbox="88 910 155 939"></td> <td data-bbox="160 910 963 939">/Info Settings</td> </tr> <tr> <td data-bbox="88 939 155 968"></td> <td data-bbox="160 939 963 968">Live View Boost</td> </tr> <tr> <td data-bbox="88 968 155 997"></td> <td data-bbox="160 968 963 997">Flicker reduction</td> </tr> <tr> <td data-bbox="88 997 155 1026"></td> <td data-bbox="160 997 963 1026">Displayed Grid</td> </tr> <tr> <td data-bbox="88 1026 155 1055"></td> <td data-bbox="160 1026 963 1055">Peaking Color</td> </tr> <tr> <td colspan="2" data-bbox="88 1055 963 1084">B2. Disp//PC</td> </tr> <tr> <td data-bbox="88 1084 155 1113"></td> <td data-bbox="160 1084 963 1113"></td> </tr> <tr> <td data-bbox="88 1113 155 1142"></td> <td data-bbox="160 1113 963 1142">HDMI</td> </tr> <tr> <td colspan="2" data-bbox="88 1142 963 1172">C. Exp/ISO</td> </tr> <tr> <td data-bbox="88 1172 155 1201"></td> <td data-bbox="160 1172 963 1201">Exposure Shift</td> </tr> <tr> <td data-bbox="88 1201 155 1230"></td> <td data-bbox="160 1201 963 1230">ISO-Auto Set</td> </tr> <tr> <td data-bbox="88 1230 155 1259"></td> <td data-bbox="160 1230 963 1259">Noise Filter</td> </tr> <tr> <td data-bbox="88 1259 155 1288"></td> <td data-bbox="160 1259 963 1288">Noise Reduct.</td> </tr> </tbody> </table>		A. MF			MF Assist	B1. Disp//PC			/Info Settings		Live View Boost		Flicker reduction		Displayed Grid		Peaking Color	B2. Disp//PC					HDMI	C. Exp/ISO			Exposure Shift		ISO-Auto Set		Noise Filter		Noise Reduct.
A. MF																																	
	MF Assist																																
B1. Disp//PC																																	
	/Info Settings																																
	Live View Boost																																
	Flicker reduction																																
	Displayed Grid																																
	Peaking Color																																
B2. Disp//PC																																	
	HDMI																																
C. Exp/ISO																																	
	Exposure Shift																																
	ISO-Auto Set																																
	Noise Filter																																
	Noise Reduct.																																

⑤  Custom Menu (P. 61)	
D.  Custom	
	 + 
	 +WB
E.  /WB/Color	
	 Set
	WB
	 Keep Warm Color
	Color Space
F. Record	
	File Name
	Edit Filename
	Copyright Settings
G. Field Sensor	
	Elevation / Depth
	Record GPS location
	GPS Priority
H.  Utility	
	Pixel Mapping
	Level Adjust
	Sleep
	Eye-Fi
	Certification

⑥  Setup Menu (P. 70)	
Card Setup	
 Settings	Rec View
	Wi-Fi Settings

Using the menus

Press the **MENU** button during shooting or playback to display the menu. The menu provides access to a variety of camera settings, such as shooting and playback functions, time and date settings, and display options. Some features may be unavailable depending on the shooting mode and camera settings.  "List of settings available in each shooting mode" (P. 111)

1 Press the **MENU** button to display the menus.

- A guide is displayed in 2 seconds after you select an option.
- Press the **INFO** button to view or hide guides.

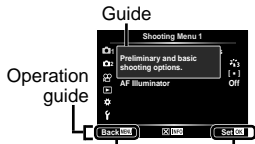

Press the **MENU** button to go back one screen

Press the **OK** button to confirm the setting

2 Use Δ / ∇ (arrow pad) to select the desired page tab and press \triangleright .



- The menu group tab appears when the Custom Menu is selected. Use Δ / ∇ to select the menu group and press the **OK** button.

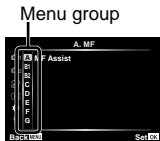

- 3 Use $\Delta \nabla$ (arrow pad) to select the desired submenu 1 and then press the $\text{\textcircled{OK}}$ button.

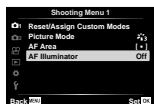

Submenu 2



- 4 Use $\Delta \nabla$ (arrow pad) to select the desired submenu 2 and then press the $\text{\textcircled{OK}}$ button.

- Once a setting is selected, the display returns to the Submenu 1.
- Depending on the item selected, additional steps may be required.

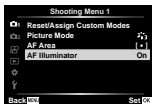

- 5 Press the **MENU** button to complete the setting.

For the operation method, refer to (P. 50).

- The default settings of the function are highlighted in .





Shooting Menu 1

Restoring default settings/saving settings

[Reset/Assign Custom Modes]

Restoring Default Settings





Camera settings can be easily restored to default settings.  “Menu directory” (P. 116)

- ① In Shooting Menu 1, highlight [Reset/Assign Custom Modes] and press the  button.
- ② Highlight [Reset] and press the  button or  (arrow pad).
- ③ Choose the reset type.
 - To reset all settings except those such as time, date, and language, highlight [Full] and press the  button.
- ④ Highlight [Yes] and press the  button.

Saving Settings

Current settings can be saved to either of two Custom Modes. The saved settings can be recalled by rotating the mode dial to C1 or C2.  “Menu directory” (P. 116)





Submenu 2	Submenu 3	Application
Custom Mode C1	Set	Save current settings.
	Reset	Return to the default setting.
Custom Mode C2	Set	The same as Custom Mode C1.
	Reset	

- ① Adjust settings in order to save.
 - Rotate the mode dial to a position other than  (movie mode).
- ② In Shooting Menu 1, highlight [Reset/Assign Custom Modes] and press the  button.
- ③ Highlight [Custom Mode C1] or [Custom Mode C2] and press the  button.
- ④ Highlight [Set] and press the  button.
 - Any existing settings are overwritten.
 - To cancel the registration, select [Reset].





For the operation method, refer to (P. 50).

Processing options [Picture Mode]

You can make individual adjustments to contrast, sharpness and other parameters in [Picture Mode] (P. 35) settings. Changes to parameters are stored for each picture mode separately.

- ① Select [Picture Mode] in Shooting Menu 1 and press the  button.
 - The camera will display the picture mode available in the current shooting mode.
- ② Select an option with   and press the  button.
 - Press  to set the detailed options for the selected picture mode. Detailed options are not available for some picture modes.
 - Changes to contrast have no effect at settings other than [Normal].

Selecting the focusing area [AF Area]

Submenu 2	Application
 (All Targets)	The camera automatically chooses from the full set of focus targets.
 (Single Target)	You can choose a single AF target.  "Area" (P. 32)
Tracking	The camera tracks the subject movement automatically to focus on it continuously.  "AF Tracking" (P. 33)

Using the assist lamp for shooting a dark subject [AF Illuminator]

Submenu 2	Application
Off	The AF illuminator is not used.
On	When the shutter button is pressed halfway down, the AF illuminator turns on to aid focusing.

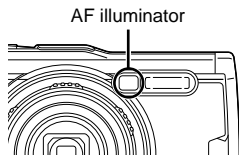

For the operation method, refer to (P. 50).

Shooting Menu 2

Adjusting interval settings [Intrvl. Sh./Time Lapse]

Submenu 2	Submenu 3	Submenu 4	Application
Off	—	—	Interval shooting off.
On	Number of Frames	1 to 299 (frames)	Sets the number of frames to shoot.
	Start Waiting Time	00:00:00 to 24:00:00 (minutes)	Sets the waiting time before shooting starts.
	Interval Length	00:00:01 to 24:00:00 (minutes)	Sets the interval time after shooting starts.
	Time Lapse Movie	Off	Store each of the frames as a picture.
		On	In addition to storing the still pictures, create a movie from the sequence of frames and store it.
	Movie Settings	Movie Resolution	Choose a size for time lapse movies.
Frame Rate		Choose a frame rate for time lapse movies.	

Using Interval Shooting

Select [On] for [Intrvl. Sh./Time Lapse] in Shooting Menu 2 before adjusting shooting settings and taking photographs.

- The interval may be longer than the set interval such as when the camera takes a few moments for image processing.
- Use a USB-AC adapter for prolonged interval shooting.
- Interval shooting will not start if the space remaining on the memory card is insufficient.
- During interval shooting the power may turn off, but the shooting is still performed according to the setting.

Cancelling or Ending Interval Shooting

Press the **MENU** to cancel interval shooting. To end interval shooting, select [Off] for [Intrvl. Sh./Time Lapse] in Shooting Menu 2.

For the operation method, refer to (P. 50).

Setting the focus bracket shooting [Focus BKT]

Submenu 2	Submenu 3	Submenu 4	Application
Off	—	—	Bracketing disabled.
On	Set number of shots	10/20/30	Sets the number of frames in the bracket shooting.
	Set focus differential	Narrow/Normal/Wide	Sets the interval between the shifted focus positions.



Video Menu

Recording sound when shooting movies [Movie

Submenu 2	Application
Off	No sound is recorded.
On	Sound is recorded.
On 	Sound is recorded; wind noise reduction is enabled while recording is in progress.

- Sound is not recorded in the [Diorama] of picture mode or HS movie mode.

Adjusting the microphone volume [Recording Volume]

Adjust the sensitivity of the built-in microphone. Adjust the sensitivity using   while checking the peak sound level picked up by the microphone over the previous few seconds.

Choosing a frame rate for movies [Video Frame Rate]

Submenu 2	Application
30p/25p	Choose the movie frame rate. <ul style="list-style-type: none">• Select [30p] to choose from image quality settings (P. 39) of 30p and 60p, [25p] to choose from settings of 25p and 50p.

For the operation method, refer to (P. 50).



Choosing movie image quality [Video Bit Rate]

Submenu 2	Application
Super Fine/ Fine/Normal	Choose a compression ratio for movie image data.



Playback Menu

Playing back pictures automatically

Submenu 2	Submenu 3	Application
Start	—	Starts the slideshow.
BGM	Party Time/Off	Selects the background music options.
Slide	All/Still Picture/ Movie	Set the type of data to be played back.
Slide Interval	2 sec/3 sec/ 4 sec/5 sec/ 6 sec/7 sec/ 8 sec/9 sec/ 10 sec	Choose the length of time each slide is displayed from 2 to 10 seconds.
Movie Interval	Full/Short	Select [Full] to play back full length of each movie clip in the slideshow or [Short] to play back only the opening portion of each movie clip.

- During a slideshow, press  (arrow pad) to advance one frame,  to go back one frame.
- Press the **MENU** button or the  button to stop the slideshow.

Choosing a Background Track

You can change [Party Time] to different BGM. After downloading tracks from the Olympus website onto the memory card, select  > [BGM] in the playback menu, highlight [Party Time], and press  (arrow pad). Visit the following website for the download.

<http://support.olympus-imaging.com/bgmdownload/>

For the operation method, refer to (P. 50).



Rotating images

Submenu 2	Application
Off	Images are not rotated for playback.
On	Photographs taken in "tall" (portrait) orientation are automatically rotated for display in the monitor during playback.

Editing still images [Edit]

Submenu 2	Submenu 3	Submenu 4	Application
Sel. Image	RAW Data Edit	Current	The JPEG copy is processed using the current camera settings. <ul style="list-style-type: none"> Adjust the camera settings before choosing this option. Some settings such as exposure compensation are not applied.
		ART BKT	The image is edited using settings for the selected art filter.
		No	Exit without editing the image.
	JPEG Edit	Shadow Adj	Brightens a dark backlit subject.
		Redeye Fix	Reduces the red-eye phenomenon due to flash shooting.
			Trims an image. Use the control dial to choose the size of the crop and $\Delta \nabla \triangleleft \triangleright$ (arrow pad) to position the crop.
		Aspect	Changes the aspect ratio of images from 4:3 (standard) to [3:2], [16:9], [1:1], or [3:4]. After changing the aspect ratio, use $\Delta \nabla \triangleleft \triangleright$ to specify the trimming position.
		Black & White	Creates black and white images.
		Sepia	Creates sepia-toned images.
	Saturation	Increases the vividness of images. Adjust the color saturation checking the image on the screen.	

For the operation method, refer to (P. 50).



Submenu 2	Submenu 3	Submenu 4	Application
Sel. Image	JPEG Edit		Converts the image size to 1280 × 960, 640 × 480, or 320 × 240. Images with an aspect ratio other than 4:3 (standard) are converted to the closest image size.
		e-Portrait	Compensates the skin look for smoothness.
	Movie Edit	In-Movie Image Capture	You can select a frame from a movie to save as a still image.
		Movie Trimming	Trim footage from the movie.
		No	Cancel recording.
		 Start	Audio can be added to still images (up to 30 sec. long).
Erase		Delete the audio recorded with the image.	
Image Overlay*1	2Images Merge	Yes	Create a new image by overlaying RAW photographs.
	3Images Merge		

*1 This option is available only if the memory card contains RAW photographs.









RAW Data Edit/JPEG Edit

- ① Use Δ ∇ to select [Sel. Image] and press the OK button.
- ② Highlight an image using \leftarrow \rightarrow or the control dial and press the OK button.
 - [RAW Data Edit] is displayed if a RAW image is selected, and [JPEG Edit] if a JPEG image is selected. For images recorded in RAW+JPEG format, both [RAW Data Edit] and [JPEG Edit] are displayed. Select the desired option from them.
- ③ Select [RAW Data Edit] or [JPEG Edit] and press the OK button.
- ④ When the settings are complete, press the OK button.
 - The settings are applied to the image.
- ⑤ Select [Yes] and press the OK button.
 - The edited image is stored in the card.
 - Red-eye correction may not work depending on the image.





For the operation method, refer to (P. 50).

- Editing of a JPEG image is not possible in the following cases:
When an image is processed on a PC, when there is not enough space in the card memory, or when an image is recorded on another camera.
- The image cannot be resized () to the larger size than the original size.
- [] (trimming) and [Aspect] can only be used to edit images with an aspect ratio of 4:3 (standard).







Audio recording

- ① Use $\Delta \nabla$ to select [Sel. Image] and press the  button.
- ② Use $\triangleleft \triangleright$ or the control dial to highlight an image and press the  button.
 - Audio recording is not available with protected images.
- ③ Select [] and press the  button.
 - To exit without adding audio, select [No].
- ④ Select [ Start] and press the  button to begin recording.
 - Recording will start.
- ⑤ Press the  button to end recording.
 - Images recorded with audio are indicated by a  icon.

In-Movie Image Capture (Movie Edit)

- ① Use $\Delta \nabla$ to select [Sel. Image] and press the  button.
- ② Use $\triangleleft \triangleright$ or the control dial to highlight a movie and press the  button.
- ③ Highlight [Movie Edit] and press the  button.
- ④ Use $\Delta \nabla$ to select [In-Movie Image Capture] and press the  button.
- ⑤ Use $\triangleleft \triangleright$ or the control dial to display the desired frame and press the  button.
 - You can edit 4K movies shot with this camera at an aspect ratio of [16:9].

Movie Trimming (Movie Edit)

- ① Use $\Delta \nabla$ to select [Sel. Image] and press the  button.
 - ② Use $\triangleleft \triangleright$ or the control dial to highlight a movie and press the  button.
 - ③ Highlight [Movie Edit] and press the  button.
 - ④ Use $\Delta \nabla$ to select [Movie Trimming] and press the  button.
 - ⑤ Select [Overwrite] or [New File] and press the  button.
 - If the image is protected, you cannot select [Overwrite].
 - ⑥ Select the starting point and press the  button.
 - To jump to the first or last frame, rotate the control dial.
 - ⑦ Use $\triangleleft \triangleright$ or the control dial to select a section to trim.
 - ⑧ Select [Yes] and press the  button.
 - The range between the first or last frame and the selected frame are deleted.
- Editing is available with movies recorded using this camera.

For the operation method, refer to (P. 50).

Image overlay

- ① Use $\Delta \nabla$ to select [Image Overlay] and press the OK button.
- ② Select the number of images to be overlaid and press the OK button.
- ③ Use $\Delta \nabla \langle \rangle$ to select the RAW images to be overlaid (P. 11).
 - The overlaid image will be displayed if images of the number specified in step ② are selected.
- ④ Adjust the gain for each image to be overlaid.
 - Use $\langle \rangle$ to select an image and $\Delta \nabla$ to adjust gain.
 - Gain can be adjusted in the range 0.1 – 2.0. Check the results in the monitor.
- ⑤ Press the OK button to display the confirmation dialog. Select [Yes] and press the OK button.
 - The image is saved with the record mode set at the time the image is saved. (If [RAW] is selected, the copy will be saved in [L]N+RAW format.)

Creating a Print Order [Print Order]

Choose print options (the number of copies and date imprinting) for the images on the memory card.  "Print reservation (DPOF)" (P. 86)

Removing protection from all images [Reset Protect]

Submenu 2	Application
Yes	Remove protection from all images on the current memory card.
No	Exit without removing protection.

Connecting to smartphones via wireless LAN

[Connection to Smartphone]

The camera can connect to smartphones using built-in wireless LAN.

 "Connecting to a smartphone" (P. 73)

For the operation method, refer to (P. 50).

Custom Menu

■ A. MF

Manual focus assist [MF Assist]



Submenu 2	Submenu 3	Application
Magnify	Off	Magnification off.
	On*1	Magnifies a portion of the screen. <ul style="list-style-type: none">The subject in the center of the frame is displayed at a higher magnification. If you are using focus lock (P. 32), the location on which focus is locked will be displayed at a higher magnification.
Peaking	Off	Peaking off.
	On*1	Displays clearly defined outlines with edge enhancement. <ul style="list-style-type: none">You can select the enhancement color.  [Peaking Color] (P. 63)

- Depending on the subject, outlines may be hard to see when [On] is selected for both [Magnify] and [Peaking].
- *1 If [On] is selected, the camera will automatically enable peaking and display the subject at a higher magnification when you change the focus point for focus lock or manual focus.

For the operation method, refer to (P. 50).

■ B1. Disp/■)/PC

Configuring the information display ✱ [Info Settings]

Submenu 2	Application
 Info	Add histogram or highlight and shadow displays to the playback information display or hide default displays.
LV-Info	Add histogram, highlight and shadow, or attitude indicator displays to the shooting information display or hide default displays. <ul style="list-style-type: none">The settings for [Custom1] and [Custom2] are stored separately.
 Settings	Choose the information displayed in index and calendar playback. <ul style="list-style-type: none">Choose whether to display the calendar and/or index displays of 4, 9, 25, or 100 thumbnail images.

Enabling exposure preview ✱ [Live View Boost]

Submenu 2	Application
Off	Changes to settings such as exposure compensation are reflected in the display in the monitor.
On	Changes to settings such as exposure compensation are not reflected in the display in the monitor; instead, brightness is adjusted to bring the display as close as possible to optimal exposure.

Reducing flicker under fluorescent or similar lighting ✱ [Flicker reduction]

Submenu 2	Application
Auto/50Hz/ 60Hz	Reduce the effects of flicker under some kinds of lighting, including fluorescent lamps.
Off	Flicker reduction disabled.

- When flicker is not reduced by the [Auto] setting, set to [50Hz] or [60Hz] in accordance with the commercial power frequency of the region where the camera is used.

For the operation method, refer to (P. 50).

Adding framing guides to the shooting display **✳ [Displayed Grid]**

Submenu 2	Application
Off	Hide framing guides.
	Show framing guides.

Choosing an outline color ✳ **[Peaking Color]**

Submenu 2	Application
White/Black/ Red/Yellow	Choose an outline color.

■ B2. Disp/■)))/PC

Adjusting beep volume ✳ **[■)))]**

Use Δ ∇ (arrow pad) to adjust the volume of the sounds made in response to camera controls. Select "0" to disable sounds such as those made when the camera focuses or the shutter is released.

Playing back images on a TV ✳ **[HDMI]**

Submenu 2	Submenu 3	Application
Output Size	4K/1080p/ 720p/480p/576p	Set the signal format to be given priority. If the TV setting does not match, it is changed automatically.
	Off	Operate with the camera.
HDMI Control	On	Operate with the TV remote control. If [On] is selected, the camera can be used only for playback.

- For the connection method, refer to "Viewing camera images on TV" (P. 80).

For the operation method, refer to (P. 50).

■ C. Exp/ISO

Choosing the standard for optimal exposure

✳ [Exposure Shift]

Submenu 2	Application
	Adjust correct exposure separately for each metering mode.

- This reduces the number of exposure compensation options available in the selected direction.
- The effects are not visible in the monitor. To make normal adjustments to the exposure, perform exposure compensation (P. 29).

Choosing the maximum and standard values for auto ISO sensitivity control

✳ [ISO-Auto Set]

Choose the upper limit and default value used for ISO sensitivity when [AUTO] is selected for ISO. [High Limit]: Choose the upper limit for auto ISO sensitivity selection. [Default]: Choose the default value for auto ISO sensitivity selection. The maximum is 12800.

Reducing image “noise” at high ISO sensitivities

✳ [Noise Filter]

Submenu 2	Application
Off	Noise reduction disabled.
Low/Standard/ High	Choose the amount of noise reduction performed at high ISO sensitivities.

Reducing image “noise” in long exposures

✳ [Noise Reduct.]

Submenu 2	Application
Off	Noise reduction disabled.
On	Noise reduction is performed with every shot.
Auto	Noise reduction is performed at slow shutter speeds, or when the internal temperature of the camera has risen.

- The time required for noise reduction is shown in the display.
- [Off] is selected automatically during sequential shooting.

For the operation method, refer to (P. 50).

- This function may not work effectively with some shooting conditions or subjects.

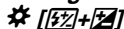

■ D. Custom

Adding flash compensation to exposure compensation



Submenu 2	Application
Off	Exposure compensation is not added to flash compensation.
On	Add exposure compensation to flash compensation.







Adjusting white balance for use with the flash

Submenu 2	Application
Off	White balance settings are not automatically adjusted for use with the flash.
 WB AUTO / 	Adjust white balance for use with a flash.

■ E. /WB/Color

Choosing JPEG image quality options [Set]

You can select the JPEG image quality mode from combinations of three image sizes and four compression rates.

- ① Use   to select a combination ( 1) – ( 4) and use   to change.
- ② Press the  button.

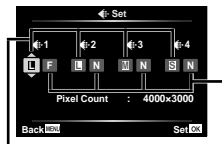

Image size Compression rate

For the operation method, refer to (P. 50).

Adjusting colors for the light source ✨ [WB]

Set the white balance (P. 36). You can also fine-tune the white balance for each mode.

Making fine adjustments to white balance

- ① Highlight the white balance option you wish to fine-tune and press ▷ (arrow pad).
- ② Highlight the A (amber–blue) or G (green–magenta) axis and use Δ ▽ (arrow pad) to choose a value.
 - Higher values on the A (amber–blue) axis give images a red cast, lower values a blue cast.
 - Higher values on the G (green–magenta) axis heighten greens, while lower values give images a magenta cast.

Adjusting auto white balance to preserve warm colors under incandescent lighting ✨ [WB AUTO Keep Warm Color]

Submenu 2	Application
Off	Reduce warm colors in pictures taken using auto white balance under incandescent lighting.
On	Preserve warm colors in pictures taken using auto white balance under incandescent lighting.

Setting the color reproduction format ✨ [Color Space]

Submenu 2	Application
sRGB	This is the RGB color space standard stipulated by the International Electrotechnical Commission (IEC). Normally, use [sRGB] as the standard setting.
AdobeRGB	This is a standard provided by Adobe Systems. Compatible software and hardware such as a display, printer etc. are required for a correct output of images.

For the operation method, refer to (P. 50).

■ F. Record

Resetting Sequential File Numbering ✳ [File Name]

Submenu 2	Application
Auto	Even when a new card is inserted, the file numbers are retained from the previous card. File numbering continues from the last number used or from the highest number available on the card.
Reset	When you insert a new card, the folder numbers starts at 100 and the file name starts at 0001. If a card containing images is inserted, the file numbers start at the number following the highest file number on the card.

Changing image file names ✳ [Edit Filename]

Choose how image files are named by editing the portion of the filename highlighted below in gray.

sRGB: Pmdd0000.jpg _____ Pmdd

Adobe RGB: mdd0000.jpg _____ mdd

Adding creator and copyright holder names to images ✳ [Copyright Settings]

Submenu 2	Application
Copyright Info.	Select [On] to include the names of the photographer and copyright holder in the Exif data for new photographs.
Artist Name	Enter the name of the photographer.
Copyright Name	Enter the name of the copyright holder.

- OLYMPUS does not accept liability for damages arising from disputes involving the use of [Copyright Settings]. Use at your own risk.

For the operation method, refer to (P. 50).

■ G. Field Sensor

Entering the altitude/depth for the current location

✳ [Elevation / Depth]

- ① Use $\Delta \nabla$ (arrow pad) to choose a value.
 - To use different units, proceed to Step ②. To proceed without changing units, press the OK button.
- ② Press \triangleright (arrow pad).
- ③ Use $\Delta \nabla$ (arrow pad) to choose the units and press the OK button.

Recording GPS data with pictures ✳ [Record GPS location]

Submenu 2	Application
Off	GPS data are not recorded with pictures.
On	Record GPS data with pictures.

- If [Off] is selected for [Record GPS location], location data will not be added to pictures even if the LOG switch is rotated to **LOG**.

Choosing a GPS mode ✳ [GPS Priority]

Submenu 2	Application
GPS accuracy	Prioritize the accuracy of GPS data over battery endurance.
Battery power	Prioritize battery endurance over data accuracy.

■ H. Utility

Adjusting the image processing function ✳ [Pixel Mapping]

- This function has already been adjusted at factory shipping, and no adjustment is needed right after purchase. Approximately once a year is recommended.
- For best results, wait at least one minute after taking or viewing pictures before performing pixel mapping. If the camera is turned off during pixel mapping, be sure to perform it again.

To adjust the image processing function

Press the OK button when [Start] (Submenu 2) is displayed.

- The check and adjustment of the image processing function starts.

For the operation method, refer to (P. 50).

Calibrating the attitude indicator [Level Adjust]

Submenu 2	Application
Reset	Resets adjusted values to the default settings.
Adjust	Sets the current camera orientation as the 0 position.

Choosing the sleep delay [Sleep]

Submenu 2	Application
Off	Disable sleep (energy saving) mode.
1 min/3 min/ 5 min	The camera will enter sleep (energy saving) mode if no operations are performed for the selected period. <ul style="list-style-type: none">• The camera can be reactivated by pressing the shutter button halfway.

Using an Eye-Fi card [Eye-Fi]

Submenu 2	Application
On	Enable wireless on Eye-Fi cards.
Off	Disable wireless on Eye-Fi cards.

- The setting can be changed when an Eye-Fi card is inserted.
- When using an Eye-Fi card, read the Eye-Fi card instruction manual carefully, and comply with the instructions.
- Use the Eye-Fi card in compliance with the laws and regulations of the country where the camera is used.
- In locations such as on an airplane, where the Eye-Fi communication is prohibited, remove the Eye-Fi card from the camera, or set [Eye-Fi] to [Off].
- This camera does not support the Eye-Fi card's Endless mode.

Checking the certification marks [Certification]

Part of the certification mark (for safety standards, etc.) is displayed.

For the operation method, refer to (P. 50).

ƒ Setup Menu

Deleting all images or all data ƒ [Card Setup]

- Before formatting, check that no important data is left in the card.
- Cards must be formatted with this camera before first use or after being used with other cameras or computers.

Submenu 2	Application
All Erase	Delete all image data from the card. <ul style="list-style-type: none">• Protected images are not deleted.
Format	Delete all data from the card, including protected images.

Setting the clock manually, choosing a time zone, and using GPS to set the clock ƒ [⌚ Settings]



- ① Press $\Delta \nabla$ of the arrow pad to select the year for [Y].
 - ② Press \triangleright of the arrow pad to save the setting for [Y].
 - ③ Select the month ([M]), day ([D]), hour and minute ([Time]), and the date display order ([Y/M/D]) using $\Delta \nabla \triangleleft \triangleright$ (arrow pad) as described in Steps ① and ②, and then press the OK button.
- When the clock is set, the time appears in the location data display (P. 46).

Time Zone

Use $\Delta \nabla$ to highlight a time zone and press the OK button.

- Daylight saving time can be turned on or off using the **INFO** button.
- To set the clock to local time when travelling, choose the time zone of your travel destination. The clock will automatically be adjusted for the change in time zone.

Auto Time Adjust

Select [On] to match the camera clock to the time received via GPS.

For the operation method, refer to (P. 50).

Changing the display language

Submenu 2	Application
Languages	The language for the menus and error messages displayed on the monitor is selected.

Adjusting the brightness of the monitor

- ① Use Δ ∇ (arrow pad) to adjust the brightness while viewing the monitor, and then press the  button.



Viewing the image immediately after shooting

Submenu 2	Application
Off	The image being recorded is not displayed. This allows the user to prepare for the next shot while following the subject in the monitor after shooting.
0.3/0.5/1 to 20 (sec)	The image being recorded is displayed for selected second(s). This allows the user to make a brief check of the image that was just taken.
AUTO 	When recording photos, the camera automatically switches to playback mode with the current image displayed.

Setting Wi-Fi [Wi-Fi Settings]

Submenu 2	Application
Wi-Fi Connect Settings	Set the connection mode.  "Connecting the camera to a smartphone" (P. 72)
Private Password	Regenerate a password.
Reset share Order	Cancel all images selected for sharing.
Reset Wi-Fi Settings	Reset Wi-Fi settings to the default settings.

- For the operation method, refer to "Changing connection method" (P. 76).

Connecting the camera to a smartphone

By connecting to a smartphone through this camera's wireless LAN function and using the specified app (OI.Track, OI.Share), you can enjoy even more features during and after shooting.

Things you can do with the specified app, OLYMPUS Image Share (OI.Share)

- Camera image transfer to a smartphone
You can load images in the camera to a smartphone.
- Remote shooting from a smartphone
You can remotely operate the camera and shoot using a smartphone.
- Beautiful image processing
You can apply art filters and add stamps on images loaded to a smartphone.
- Addition of GPS tags to camera images
You can add GPS tags to images simply by transferring the GPS log saved on the smartphone to the camera.

For details, visit the address below:

<http://app.olympus-imaging.com/oishare/>

- Before using the wireless LAN function, read "Using the wireless LAN function" (P. 123).
- If using the wireless LAN function in a country outside the region where the camera was purchased, there is a risk that the camera will not conform to the wireless communication regulations of that country. Olympus will not be held responsible for any failure to meet such regulations.
- As with any wireless communication, there is always a risk of interception by a third party.
- The wireless LAN function on the camera cannot be used to connect to a home or public access point.
- The transceiver antenna is located in the camera grip. Keep the grip away from metal objects whenever possible.
- During wireless LAN connection, the battery will run down faster. If the battery is running low, the connection may be lost during a transfer.
- Connection may be difficult or slow in proximity to devices that generate magnetic fields, static electricity or radio waves, such as near microwaves, cordless telephone.

Connecting to a smartphone

- 1 Start the OI.Share App installed on your smartphone.
 - You can also connect to smartphones using OI.Track.
- 2 Highlight [Connection to Smartphone] in the Playback Menu and press **OK**.
 - You can also launch [Connection to Smartphone] by pressing and holding the **MENU** button when the camera is ready to shoot.
- 3 Follow the operation guide displayed on the camera monitor to prepare for Wi-Fi connection.
- 4 Use the smartphone that the OI.Share is activated to read the QR code displayed in the camera monitor. The connection automatically starts.

Failure of reading QR code

Set a SSID and a password in the Wi-Fi setting of a smartphone before the connection (The SSID and the password are displayed at the lower left of QR code screen.).

For the Wi-Fi setting for your smartphone, read the instruction manual of the smartphone.

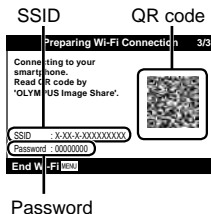

- To end the connection, press the **MENU** button of the camera.

Error message during Wi-Fi connection

Connect the camera to the smartphone again.

- ① Turn off the Wi-Fi function of your smartphone.
- ② Turn on the Wi-Fi function again. Select the SSID for TG-5 before another connection is made.

Transferring images to a smartphone

You can select images in the camera and load them to a smartphone. You can also use the camera to select images you want to share in advance.

 [Share Order] (P. 13)

- 1** Connect the camera to a smartphone. (P. 73)
- 2** Tap the Image Transfer button in OI.Share.
 - The images in the camera are displayed in a list.
 - When an error message is displayed:  "Error message during Wi-Fi connection" (P. 73)
- 3** Select the pictures you want to transfer and tap the Save button.
 - When saving is completed, you can turn off the camera from the smartphone.

Shooting remotely with a smartphone

You can shoot remotely by operating the camera with a smartphone. This is available only in [Private] (P. 76).

- 1** Connect the camera to a smartphone. (P. 73)
- 2** Tap the Remote button in OI.Share.
 - When an error message is displayed:  "Error message during Wi-Fi connection" (P. 73)
- 3** Tap the shutter button to shoot.
 - Pictures are saved to the camera memory card.
 - Available shooting options are partially limited.

Adding position information to images

You can add GPS tags to images that were taken while the GPS log was saving by transferring the GPS log saved on the smartphone to the camera. This is available only in [Private] (P. 76).

- 1** Before beginning to shoot, launch OI.Share and turn on the switch on the Add Location button to begin saving the GPS log.
 - Before beginning to save the GPS log, the camera must be connected to OI.Share once to synchronize the time.
 - You can use the phone or other apps while the GPS log is saving. Do not terminate OI.Share.
- 2** When shooting is complete, turn off the switch on the Add Location button.

Saving the GPS log is complete.
- 3** Connect the camera to a smartphone. (P. 73)
- 4** Transfer the saved GPS log to the camera using OI.Share.
 - GPS tags are added to the images on the memory card based on the data in the transferred log.
 - In the detailed playback, latitude and longitude are displayed on images to which position information has been added.
 - When an error message is displayed:  "Error message during Wi-Fi connection" (P. 73)
 - Addition of location information can only be used with smartphones that have a GPS function.
 - Position information cannot be added to movies.

Changing connection method

There are two ways to connect the camera to a smartphone: [Private], by which you use the same setting every time, and [One-Time], by which you use different setting every time.

It is recommended to use [Private] when connecting to your smartphone, and to use [One-Time] when transferring images to another smartphone.

- The factory default setting is [Private].

- 1** Select [Wi-Fi Settings] in the Setup Menu and press **OK**.
- 2** Select [Wi-Fi Connect Settings] and press **▷** (arrow pad).
- 3** Select the wireless LAN connection method and press **OK**.
 - [Private]: Connect to one smartphone (connects automatically using the settings after the initial connection). All OI.Share functions are available.
 - [One-Time]: Connect to multiple smartphones (connects using different connection settings each time). Only OI.Share's image transfer function is available. You can view only images that are set for share order using the camera.
 - [Select]: Select which method to use each time.
 - [Off]: The Wi-Fi function is turned off.

Changing password

Change the password used for [Private].

- 1** Select [Wi-Fi Settings] in the Setup Menu and press **OK**.
- 2** Select [Private Password] and press **▷** (arrow pad).
- 3** Follow the operation guide and press **⊙**.
 - A new password will be set.

Canceling a share order

Cancel share orders that are set on images.

- 1** Select [Wi-Fi Settings] in the Setup Menu and press **OK**.
- 2** Select [Reset share Order] and press **▶** (arrow pad).
- 3** Select [Yes] and press **OK**.

Resetting wireless LAN settings

Initializes content of [Wi-Fi Settings].

- 1** Select [Wi-Fi Settings] in the Setup Menu and press **OK**.
- 2** Select [Reset Wi-Fi Settings] and press **▶** (arrow pad).
- 3** Select [Yes] and press **OK**.

Using GPS function

Whether being used to take photographs or not, the camera can acquire and log GPS and other sensor data, including position and altitude. These data can also be embedded in photographs. Logs can be downloaded for use with the OLYMPUS Image Track (OI.Track) smartphone app.

- Latitude and longitude are displayed on images to which position information has been added.
- The camera is not equipped for GPS navigation.
- Be sure to use the latest version of the app.

For details, visit the address below:

<http://app.olympus-imaging.com/oitrack/>

Before you begin

- Before using the GPS function, read “GPS function, electronic compass” (P. 123).
- In certain countries and regions it may be illegal to acquire position information without prior application to the government. Because of this, in certain sales regions, the camera may be set up not to display position information.

When taking the camera abroad, be aware that some regions or countries may have laws regulating the use of this function. Be sure to abide by all local laws.

- Before boarding an aircraft or entering other locations where the use of GPS devices is prohibited, be sure to rotate the LOG switch to **OFF** and select [Off] for both [Record GPS location] (P. 68) and [Auto Time Adjust] (P. 70).
- This camera also supports Quasi-Zenith Satellites System and GLONASS.

Before using GPS function (A-GPS data)

Depending on the status of the camera and communication, it may take time to acquire the position information. When the A-GPS is used, the position determination time can be shortened from a few seconds to a few tens of seconds. The A-GPS data can be updated using the smartphone app “OLYMPUS Image Track” (OI.Track) or the PC software “OLYMPUS A-GPS Utility”.

- Make sure that the camera date is set correctly.
- Set the camera to private connection (P. 76).
- A-GPS data must be updated every 4 weeks.

The position information may have changed when time has elapsed after updating the data. Use as new A-GPS data as possible.

- The provision of A-GPS data may be terminated without prior notice.

Updating the A-GPS data using a smartphone

Before update, install the smartphone app “OLYMPUS Image Track” (OI.Track) on your smartphone. Refer to the URL below for details on how to update the A-GPS data.

<http://app.olympus-imaging.com/oitrack/>

Connect the camera and the smartphone, following the procedure described in “Connecting to a smartphone” (P. 73).

- If a connection error is displayed, you will need to re-establish the connection between the camera and smartphone.  “Error message during Wi-Fi connection” (P. 73)

Updating the A-GPS data using a PC

Download the OLYMPUS A-GPS Utility software from the URL below, and install it on your PC.

<http://sdl.olympus-imaging.com/agps/>

Refer to “OLYMPUS A-GPS Utility Instruction Manual” on the website with above URL for details on how to update the data.

Using GPS

Any of the following enable GPS: rotating the LOG switch to **LOG** (P. 44), selecting [On] for [Record GPS location] (P. 68), or selecting [On] for [Auto Time Adjust] (P. 70).

- Do not cover the GPS antenna with your hands or metal objects.
- If you are using the GPS function for the first time and the A-GPS has not been updated, or if the function has not been used for a long time, it may take a few minutes for the position measurement to end.
- Enabling GPS increases the drain on the battery. To reduce the drain on the battery when GPS is enabled, select [Battery power] for [GPS Priority] (P. 68).

Displaying tracked movement of GPS logs

After the GPS track logs are recorded, the tracked movement of the logs can be displayed using the OLYMPUS Viewer 3 or OI.Track.

- The tracked movement cannot be displayed on the camera.

Connecting the camera to another device

Viewing camera images on TV

Connecting the camera to a high-definition device using an HDMI cable gives you a high-resolution display for shooting and playback.

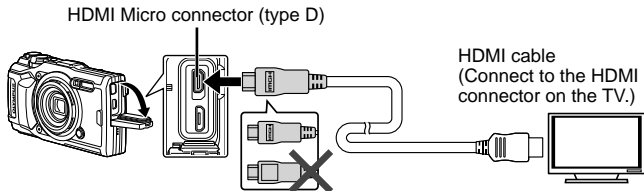

- 1 Use the cable to connect the camera to the TV.
 - 2 Turn the camera on.
 - 3 Choose the TV input channel.
 - The camera monitor turns off when the cable is connected.
 - For details on changing the input source of the TV, refer to the TV's instruction manual.
 - Depending on the TV's settings, the displayed images and information may become cropped.
- Do not connect the USB cable and HDMI cable at the same time.
 - If the camera is connected via an HDMI cable, you will be able to choose the digital video signal type. Choose a format that matches the input format selected with the TV.

4K	Priority is given to 4K HDMI output. <ul style="list-style-type: none">• Lower resolution output is used during shooting.
1080p	Priority is given to 1080p HDMI output.
720p	Priority is given to 720p HDMI output.
480p/576p	480p/576p HDMI output.

Using the TV remote control

When connected to a TV that supports HDMI control, the camera can be operated using the TV remote control. HDMI control must be enabled in the camera menus before the camera is connected.

- 1** Highlight [HDMI] in Custom Menu B2 (P. 63) and press the  button.
 - 2** Select [HDMI Control] and choose [On].
 - 3** Use the cable to connect the camera to the TV.
 - 4** Choose the TV input channel.
 - 5** Operate the camera by using the TV remote control.
 - You can operate the camera by following the operation guide displayed on the TV.
 - Some televisions may not support all features.
- You cannot shoot pictures or movies when the HDMI cable is connected.
 - Do not connect the camera to other HDMI output devices. Doing so may damage the camera.
 - HDMI output is not performed while connected via USB to a computer or printer.

Printing Pictures

Direct printing (PictBridge)

By connecting the camera to a PictBridge-compatible printer with the USB cable, you can print out recorded pictures directly.

Connecting the camera

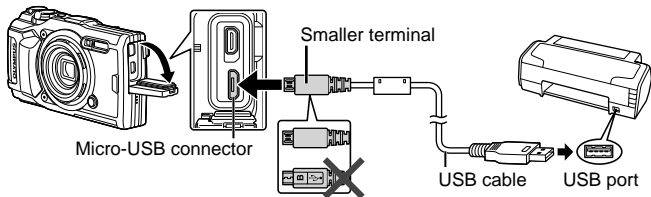

- Use a fully charged battery for printing.
- Movies cannot be printed.

■ Easy printing

Select the each of the images you want to print in single-frame playback (P. 10).

1 Use ◀▶ (arrow pad) to display the pictures you want to print on the camera.

2 Connect the camera to the printer using the supplied USB cable.

- If the “Easy Print Start” dialog is not displayed, disconnect and then reconnect the USB cable before repeating the process from Step 1.

3 Press ▶ (arrow pad).

- The picture selection screen appears when printing is completed. To print another picture, use ◀▶ (arrow pad) to select the image and press **OK**.
- To exit, unplug the USB cable from the camera while the picture selection screen is displayed.

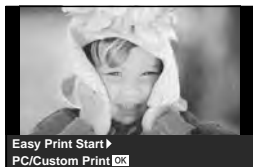

■ Custom printing

Adjust print mode, paper type, and other settings before printing.

- 1 Connect the camera to the printer using the supplied USB cable and turn the camera on.
- 2 A list of options will be displayed. Highlight [Print] and press the  button.

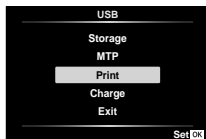

- A dialog should be displayed in the monitor prompting you to choose a print mode. If it is not, disconnect the USB cable and then reconnect it to the printer.

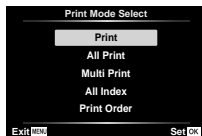

- 3 Follow the operation guide to set a print option.

Selecting the print mode

Select the type of printing (print mode). The available print modes are as shown below.

Print	Prints selected pictures.
All Print	Prints all the pictures stored in the card and makes one print for each picture.
Multi Print	Prints multiple copies of one image in separate frames on a single sheet.
All Index	Prints an index of all the pictures stored in the card.
Print Order	Prints according to the print reservation you made (P. 86). If there is no picture with print reservation, this is not available.

Setting the print paper items

This setting varies with the type of printer. If only the printer's STANDARD setting is available, you cannot change the setting.

Size	Sets the paper size that the printer supports.
Borderless	Selects whether the picture is printed on the entire page or inside a blank frame.
Pics/sheet	Selects the number of pictures per sheet. Displayed when you have selected [Multi Print].

Selecting pictures you want to print

Select pictures you want to print. The selected pictures can be printed later (single-frame reservation) or the picture you are displaying can be printed right away.



Print (OK)	Prints the currently displayed picture. If there is a picture that [Single Print] reservation has already been applied to, only that reserved picture will be printed.
Single Print (▲)	Applies print reservation to the currently displayed picture. If you want to apply reservation to other pictures after applying [Single Print], use <◀▶ (arrow pad) to select them.
More (▼)	Sets the number of prints and other items for the currently displayed picture, and whether or not to print it. For operation, refer to "Setting printing data" in the next section.

Setting printing data

Select whether to print printing data such as the date and time or file name on the picture when printing.

	Sets the number of prints.
Date	Prints the date and time recorded on the picture.
File Name	Prints the file name recorded on the picture.
	Trims an image. Use the control dial to choose the size of the crop and ▲ ▼ ◀ ▶ (arrow pad) to position the crop.

4 Once you have set the pictures for printing and printing data, select [Print], then press **OK**.

- To stop and cancel printing, press **OK**. To resume printing, select [Continue].

■ **Cancelling printing**

To cancel printing, highlight [Cancel] and press **OK**. Note that any changes to the print order will be lost; to cancel printing and return to the previous step, where you can make changes to the current print order, press **MENU**.

Print reservation (DPOF)



In print reservations, the number of prints and date imprint option are saved in the image on the card. This enables easy printing at a printer or print shop supporting DPOF by using only the print reservations on the card without a computer or a camera.

- Print reservations can be set only for the images stored on the card.
- DPOF reservations set by another DPOF device cannot be changed by this camera. Make changes using the original device. Making new DPOF reservations with this camera will erase the reservations made by the other device.
- DPOF print reservations can be made for up to 999 images per card.

■ Single-frame print reservations []

1 Press the **MENU** button to display the menus.

- “Using the menus” (P. 50)

2 From the  Playback Menu, select [Print Order] and then press the  button.

3 Use Δ ∇ (arrow pad) to select [], and press the  button.



4 Use \triangleleft \triangleright (arrow pad) to select the image for print reservation. Use Δ ∇ (arrow pad) to select the quantity. Press the  button.

5 Use Δ ∇ (arrow pad) to select the [] (date print) screen option, and press the  button.

Submenu 2	Application
No	This prints the image only.
Date	This prints the image with the shooting date.
Time	This prints the image with the shooting time.

- When printing images, the setting cannot be changed between the images.

6 Use Δ ∇ (arrow pad) to select [Set], and press the  button.

■ Reserving one print each of all images on the card [ALL]

1 Follow Steps 1 and 2 in [] (P. 86).

2 Use $\Delta \nabla$ (arrow pad) to select [ALL], and press the OK button.

3 Follow Steps 5 and 6 in [].

■ Resetting all print reservation data

1 Follow Steps 1 and 2 in [] (P. 86).

2 Select either [] or [ALL], and press the OK button.

3 Use $\Delta \nabla$ (arrow pad) to select [Reset], and press the OK button.

■ Resetting the print reservation data for selected images

1 Follow Steps 1 and 2 in [] (P. 86).

2 Use $\Delta \nabla$ (arrow pad) to select [], and press the OK button.

3 Use $\Delta \nabla$ (arrow pad) to select [Keep] and press the OK button.

4 Use $\triangleleft \triangleright$ (arrow pad) to select the image with the print reservation you want to cancel. Use $\Delta \nabla$ (arrow pad) to set the print quantity to "0".

5 If necessary, repeat Step 4, and then press the OK button when finished.

6 Use $\Delta \nabla$ (arrow pad) to select the [] (date print) screen option, and press the OK button.

- The settings are applied to the remaining images with the print reservation data.

7 Use $\Delta \nabla$ (arrow pad) to select [Set], and press the OK button.

Connecting the camera to a computer

Connecting the camera

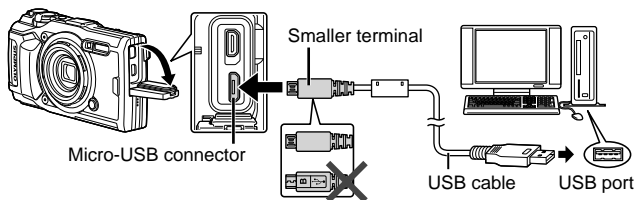

- If nothing is displayed on the camera screen even after connecting the camera to the computer, the battery may be exhausted. Use a full-charged battery.
- If the camera cannot connect to PC, disconnect and reconnect the cable.
- The battery can be charged while the camera is connected to the computer via USB. The charging time varies depending on the performance of the computer. (There may be cases in which it takes approx. 10 hours.)

Copying pictures to a computer

Your camera supports the USB Mass Storage Class. You can transfer images to a computer by connecting the camera to the computer with the provided USB cable. The following operating systems are compatible with the USB connection:

Windows	Windows Vista SP2/Windows 7 SP1/Windows 8/ Windows 8.1/Windows 10
Mac	OS X v10.8-v10.11/macOS v10.12

- 1 Turn the camera off and connect it to the computer.
 - The location of the USB port varies with the computer. For details, refer to your computer's manual.
- 2 A list of options will be displayed. Highlight [Storage] or [MTP] and press the  button.

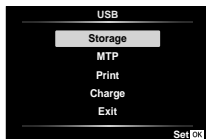

Submenu 1	Application
Storage	Connect camera as a card reader.
MTP	Treat the camera as a portable device.

- 3 The computer recognizes the camera as a new device.
 - To use Windows Photo Gallery, select [MTP] in Step 2.
 - Data transfer is not guaranteed in the following environments, even if your computer is equipped with a USB port.
 - Computers with a USB port added by means of an extension card, etc.
 - Computers without a factory-installed OS and home-built computers
 - Camera controls can not be used while the camera is connected to a computer.
 - If the computer does not detect the camera, disconnect the USB cable and then reconnect it to the computer.

Installing Software

The photographs and movies you have shot with your camera can be transferred to a computer and viewed, edited, and organized using the OLYMPUS Viewer 3 offered by OLYMPUS.

- To install OLYMPUS Viewer 3, download it from the website below and follow the on-screen instructions.
<http://support.olympus-imaging.com/ov3download/>
- Visit the website above for system requirements and installation instructions.
- You will be required to enter the product serial number prior to download.

Installing the OLYMPUS Digital Camera Updater

Camera firmware updates can only be performed using the OLYMPUS Digital Camera Updater. Download the updater from the website below and install it according to the on-screen instructions.

<http://oup.olympus-imaging.com/ou1download/index/>

User Registration

Visit the OLYMPUS website for information on registering your OLYMPUS products.

Usage Tips

If the camera does not work as intended, or if an error message is displayed on the screen, and you are unsure of what to do, refer to the information below to fix the problem(s).

Troubleshooting

■ Battery

The camera does not work even when batteries are installed.

- Insert recharged batteries in the correct direction.  “Inserting and removing the battery and card” (P. 4)
- Battery performance may have been reduced temporarily due to low temperature. Take the batteries out of the camera, and warm them by putting them in your pocket for a while.

■ Card

An error message is displayed.



-  “Error message” (P. 93)

■ Shutter button

No picture is taken when the shutter button is pressed.

- Cancel sleep mode.

If no operations are performed for a set period while the camera is on, the camera will enter a power-saving state called “sleep mode” and the monitor will turn off automatically. No picture is taken even if the shutter button is fully pressed in this mode. Operate the zoom lever or other buttons to restore the camera from sleep mode before taking a picture. If the camera is left for another 5 minutes, it automatically turns off. Press the **ON/OFF** button to turn the camera on.

- Press the  button to switch to the shooting mode.
- Wait until  (flash charge) stops blinking before taking pictures.
- With prolonged camera use, the internal temperature may increase, resulting in automatic shutdown. If this occurs, wait until the camera has sufficiently cooled.

The camera's external temperature may also increase during use, however this is normal and does not indicate malfunction.

■ Monitor

Difficult to see.

- Condensation may have occurred. Turn off the power, and wait for the camera body to become acclimated to the surrounding temperature and dry out before taking pictures.

The light is caught in the picture.

- Shooting with flash in dark situations results in an image with many flash reflections on dust in the air.

■ Date and time function

Date and time settings return to the default setting.

- If the batteries are removed and left out of the camera for about 3 days*¹, the date and time settings return to the default setting, and must be reset.

*¹ The time until the date and time settings return to the default setting varies depending on how long the batteries have been loaded.

 "Turning on the camera and making the initial settings" (P. 8)

■ Lens

Lens gets fogged.

- For rapid temperature change, lens fogging (condensation) may occur. Turn off the power, and wait for the camera body to become acclimated to the surrounding temperature and dry out before taking pictures.











■ Miscellaneous

The heading is not correct

- The compass does not function as expected in the vicinity of strong electromagnetic fields, such as from televisions, microwaves, large electric motors, radio transmitters, and high-voltage power lines. Normal function can sometimes be restored by moving the camera in a figure eight while rotating your wrist.







Error message

- When one of the messages below is displayed on the monitor, check the corrective action.

Error message	Corrective action
 Card Error	Card problem Insert a new card.
 Write Protect	Card problem The card write-protect switch is set to the "LOCK" side. Release the switch.
 Card Full	Card problem <ul style="list-style-type: none">Replace the card.Erase unwanted images.*1
	Card problem Use $\Delta \nabla$ (arrow pad) to select [Format], and press the OK button. Next, use $\Delta \nabla$ (arrow pad) to select [Yes], and press the OK button.*2
 No Picture	Card problem Take pictures before viewing them.
 Picture Error	Problem with selected image Use photo retouch software, etc. to view the image on a computer. If the image still cannot be viewed, the image file is corrupted.
 The Image Cannot Be Edited	Problem with selected image Use photo retouch software, etc. to edit the image on a computer.
 Battery Empty	Battery problem Charge the battery.
 No Connection	Connection problem Check that the camera is correctly connected to the computer, television, or printer.
 No Paper	Printer problem Load paper into the printer.



*1 Before erasing important images, download them to a computer.

*2 All data will be erased.



Error message	Corrective action
 No Ink	Printer problem Refill the ink in the printer.
 Jammed	Printer problem Remove the jammed paper.
Settings Changed* ³	Printer problem Return to the status where the printer can be used.
 Print Error	Printer problem Turn off the camera and printer, check the printer for any problems, and then turn the power on again.
 Cannot Print* ⁴	Problem with selected image Use a computer to print.
 °C/°F	Camera internal temperature warning Turn off the camera and wait for the internal temperature to cool.
 Internal camera temperature is too high. Please wait for cooling before camera use.	Camera internal temperature warning Wait a moment for the camera to turn off automatically. Allow the internal temperature of the camera to cool before resuming operations.

*3 This is displayed, for instance, when the printer's paper tray has been removed. Do not operate the printer while making the print settings on the camera.

*4 This camera may be unable to print images taken by other cameras.

Error message	Corrective action
 <p>Logging function cannot be used at this time.</p>	<p>Log recording problems</p> <ul style="list-style-type: none"> • The area of camera memory used for temporary storage of the log file is full. Insert a memory card or confirm that the current card is correctly inserted and transfer to log file to the memory card. • The battery is exhausted. Charge the battery. • The camera is connected to a television or other device via an HDMI cable. Disconnect the HDMI cable. • Wireless data transfer is in progress. End transfer. • The USB-AC adapter is being used to supply power to the camera from an electrical outlet while the battery is removed. Insert the battery and unplug the USB-AC adapter from the outlet.
 <p>Card log capacity is full. Cannot record new log files.</p>	<p>Log data problems</p> <p>The current log cannot be saved to the card. Copy log files to a computer and delete them from the card.</p> <ul style="list-style-type: none"> • Each card can store up to 199 log files.
 <p>(blinks)</p>	<p>Log data problems</p> <ul style="list-style-type: none"> • The current log has not been saved to the card. Insert the card correctly and save the log to the card. • The current log cannot be saved to the card. Copy log files to a computer and delete them from the card. <ul style="list-style-type: none"> • Each card can store up to 199 log files. <p>Card problem</p> <ul style="list-style-type: none"> • Insert a new card. • The card write-protect switch is set to the “LOCK” side. Release the switch. • Erase unwanted images.*5

*5 Before erasing important images, download them to a computer.



Error message	Corrective action
	<p>Log recording problems</p> <ul style="list-style-type: none"> • The area of camera memory used for temporary storage of the log file is full. Insert a memory card or confirm that the current card is correctly inserted and transfer to log file to the memory card. • The battery is exhausted. Charge the battery. • The camera is connected to a television or other device via an HDMI cable. Disconnect the HDMI cable. • Wireless data transfer is in progress. End transfer. • The USB-AC adapter is being used to supply power to the camera from an electrical outlet while the battery is removed. Insert the battery and unplug the USB-AC adapter from the outlet. • The clock is not set. Set the clock and choose a time zone.
	<p>GPS problems</p> <p>GPS malfunction. Turn the camera off and then on again; if the message does not clear from the display, contact an OLYMPUS service representative.</p>

Shooting tips

When you are unsure of how to take a picture that you envision, refer to the information below.

■ Focusing

Focusing on the subject.

- **Taking a picture of a subject not in the center of the monitor.**
After focusing on an object at the same distance as the subject, compose the shot, and take the picture.
Pressing the shutter button halfway  P. 9
- **Taking a picture in [AF Tracking] mode.**  P. 33
The camera tracks the subject movement automatically to focus on it continuously.
- **Taking a picture of a shadowy subject.**  P. 53
Using the AF illuminator makes focusing easier.

- **Taking a picture of subjects where autofocus is difficult.**

In the following cases, after focusing on an object (by pressing the shutter button halfway down) with high contrast at the same distance as the subject, compose the shot, and take the picture.

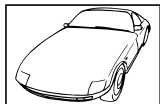

Subject with low contrast

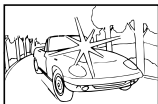

Excessively bright light in center of frame

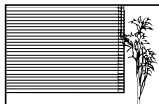

Subject containing no vertical lines *1



Subjects at different distances

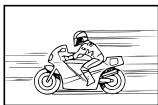

Fast-moving subject



Subject not inside AF area

*1 It is also effective to compose the shot by holding the camera vertically to focus, and then returning to the horizontal position to take the picture.

- **Camera shake**

Taking pictures without camera shake.

- **Taking pictures using “Image stabilizer (still images)”.** P. 40

The camera detects camera movement to reduce the blur even if the ISO sensitivity is not increased. This function is also effective when taking pictures at a high zoom magnification.

- **Shooting movies using “Image stabilizer (movies)”.** P. 40

- **Select [Motion] > [Sport] in SCN mode.** P. 23

The [Sport] mode uses a fast shutter speed and can reduce the blur incurred by a moving subject.

- **Taking pictures at a high ISO sensitivity.** P. 36

If a high ISO sensitivity is selected, pictures can be taken at a high shutter speed even at locations where a flash cannot be used.





- **Exposure (brightness)**

Taking pictures with the right brightness.

- **Taking pictures of a subject against a backlight**

Faces or backgrounds are bright even when shot against backlight.

Backlight HDR P. 23

- **Taking pictures using [Spot].**  P. 42
Brightness is matched with a subject in the center of the screen and the image is not affected by background light.
- **Taking pictures using [Fill In] flash.**  P. 28
A subject against backlight is brightened.
- **Taking pictures of a white beach or snow scene.**  P. 23
Select [Scenery] >  Beach & Snow] in **SCN** mode.
- **Taking pictures using exposure compensation.**  P. 29
Adjust the brightness while viewing the screen for taking the picture. Normally, taking pictures of white subjects (such as snow) results in images that are darker than the actual subject. Use the exposure compensation to adjust in the positive (+) direction to express whites as they appear. When taking pictures of black subjects, on the other hand, it is effective to adjust in the negative (-) direction.

■ Color hue

Taking pictures with colors at the same shade as they appear.

- **Taking pictures by selecting white balance.**  P. 36
Best results in most environments can normally be obtained with the [WB Auto] setting, but for some subjects, you should try experimenting with different settings. (This is especially true for sunshade under a clear sky, mixed natural and artificial light settings, and so on.)

■ Image quality

Taking sharper pictures.

- **Taking pictures at a low ISO sensitivity.**  P. 36
If the picture is taken with a high ISO sensitivity, noise (small colored spots and color unevenness that were not in the original image) can occur, and the image can appear grainy.

Playback/Editing tips



■ Playback

Viewing images with high picture quality on a highdefinition TV.

- **Connect the camera to the TV using an HDMI cable.**  P. 80

■ Editing

Erasing the sound recorded to a still image.

- **Display the image with the audio you wish to delete and select  > [Erase].**  P. 58

Cleaning and storing the camera

Camera care

Exterior:

- Wipe gently with a soft cloth. If the camera is very dirty, soak the cloth in mild soapy water and wring well. Wipe the camera with the damp cloth and then dry it with a dry cloth. If you have used the camera at the beach, use a cloth soaked in clean water and well wrung.
 - Foreign materials may be attached to the camera when using the camera in conditions with foreign materials such as dirt, dust or sand. If you continue to use the camera in such conditions, it could cause damage to the camera. To avoid such damage, wash the camera using the following method.
- ① Close and lock the battery/card compartment cover and connector cover firmly. (P. 4)
 - ② Fill a bucket or other container with fresh water, immerse the camera facing downward in the bucket and shake the camera thoroughly. And rinse the camera by placing it directly under a strong stream of tap water with pressing the button.

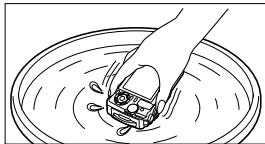

Monitor:

- Wipe gently with a soft cloth.

Lens:

- Blow dust off the lens with a commercial blower, then wipe gently with a lens cleaner.
- Do not use strong solvents such as benzene or alcohol, or a chemically treated cloth.
- Mold may form on the lens surface if the lens is left dirty.

Battery/USB-AC adapter:

- Wipe gently with a soft, dry cloth.

Storage

- When storing the camera for extended periods, remove the battery, adapter and card, and keep in a cool, dry place that is well ventilated.
- Periodically insert the battery and test the camera functions.
- Avoid leaving the camera in places where chemical products are handled since this may result in corrosion.

Using a separately sold charger

A charger (UC-90: sold separately) can be used to charge the battery.

Using your charger and USB-AC adapter abroad

- The charger and USB-AC adapter can be used in most home electrical sources within the range of 100 V to 240 V AC (50/60Hz) around the world. However, depending on the country or area you are in, the AC wall outlet may be shaped differently and the charger and USB-AC adapter may require a plug adapter to match the wall outlet. For details, ask at your local electrical shop or travel agent.
- Do not use travel voltage converters as they could damage your charger and USB-AC adapter.

Using the card

Cards compatible with this camera

SD/SDHC/SDXC/Eye-Fi (with Wireless LAN function) card (commercially available)

(for compatibility card details, visit the Olympus website.)

Eye-Fi card

- Use the Eye-Fi card in compliance with the laws and regulations of the country where the camera is used. Remove the Eye-Fi card from the camera or disable the card functions in airplanes and other locations where use is prohibited.
- The Eye-Fi card may become hot during use.
- When using an Eye-Fi card, the battery may run out faster.
- When using an Eye-Fi card, the camera may function more slowly.

SD/SDHC/SDXC card write-protect switch

The SD/SDHC/SDXC card body has a write-protect switch. If you set the switch to the “LOCK” side, you will not be able to write to the card. Return the switch to enable writing.



Format

Cards must be formatted with this camera before first use or after being used with other cameras or computers.

Readout/recording process of the card

During shooting, the current memory indicator lights up in red while the camera is writing data. Never open the battery/card cover or unplug the USB cable. This can not only damage the image data but also render the card unusable.

File storage locations

Data on the card are stored in the following folders:

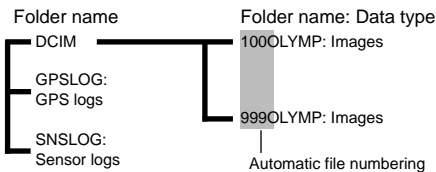

Number of Images (Stills)/Length of Footage (Movies) per Card

- The figures for the number of storable still pictures and recording length are approximate. The actual capacity varies with shooting conditions and the card used.
- The table below shows the approximate number of images and length of footage that can be stored on a 4 GB card.





Still pictures*1

Icon	Image quality	Image size	Number of storable pictures
RAW	RAW	4000×3000	270
L SF+RAW	[L] SF+RAW		164
L F+RAW	[L] F+RAW		187
L N+RAW	[L] N+RAW		220
L B+RAW	[L] B+RAW		233
M SF+RAW	[M] SF+RAW	3200×2400	190
M F+RAW	[M] F+RAW		210
M N+RAW	[M] N+RAW		234
M B+RAW	[M] B+RAW		244
S SF+RAW	[S] SF+RAW	1280×960	250
S F+RAW	[S] F+RAW		255
S N+RAW	[S] N+RAW		260
S B+RAW	[S] B+RAW		262
L SF	[L] SF	4000×3000	436
L F	[L] F		638
L N	[L] N		1231
L B	[L] B		1766
M SF	[M] SF	3200×2400	673
M F	[M] F		975
M N	[M] N		1846
M B	[M] B		2593
S SF	[S] SF	1280×960	3385
S F	[S] F		4514
S N	[S] N		7170
S B	[S] B		8706

*1 Examples of image size when the aspect ratio is 4:3.

Movies

Icon	Image size/bit rate/frame rate	Recording length	
		With sound	Without sound
[Standard] is selected for  *1			
	1920×1080 Super Fine 60p	10 min.	
	1920×1080 Super Fine 50p		
	1920×1080 Super Fine 30p		
	1920×1080 Super Fine 25p		
	1280×720 Super Fine 30p	20 min.	
	1280×720 Super Fine 25p		
	1920×1080 Fine 60p	17 min.	
	1920×1080 Fine 50p		
	1920×1080 Fine 30p		
	1920×1080 Fine 25p		
	1280×720 Fine 30p	29 min.	
	1280×720 Fine 25p		
	1920×1080 Normal 60p		
	1920×1080 Normal 50p		
	1920×1080 Normal 30p		
	1920×1080 Normal 25p		
	1280×720 Normal 30p		
	1280×720 Normal 25p		
[4K] is selected for 			
	3840×2160 30p	5 min.	
	3840×2160 25p		

Icon	Image size/bit rate/frame rate	Recording length	
		With sound	Without sound
[High-speed] is selected for  *2			
	1920×1080 HighSpeed 120fps	20 sec.	
	1280×720 HighSpeed 240fps		
	640×360 HighSpeed 480fps		

*1 The recording length is up to 29 minutes in the HD quality specified.

*2 The recording length is up to 20 sec. in the HS quality specified.

- The maximum file size of a single movie is 4GB, regardless of the capacity of the card.

Increasing the number of pictures that can be taken

Delete unwanted images or connect the camera to a computer or other device and transfer the images to long-term storage before deleting them from the card.

 [Erase] (P. 16), [Erase Selected] (P. 11), [Format] (P. 70)

Taking pictures with the Olympus Wireless RC Flash System

You can take pictures and underwater pictures with a wireless flash when using a flash compatible with the Olympus Wireless RC Flash System.

The guideline of the setup range in wireless flash shooting is from 1 to 2 m, however note that it varies depending on the ambient environment.

- The camera's built-in flash is used for communication between the camera and flash.
- To use a dedicated underwater strobe, prepare an underwater case, a fiber-optic cable and so on.
- For details about operation of a wireless flash and an underwater strobe, refer to the instruction manual for a special external flash or an underwater case.

1 Turn on the dedicated strobe.

2 Set the flash mode of the dedicated strobe to RC mode.

When you have to set a channel and a group, select CH1 for the channel, A for the group.

3 Select the flash in the Live Control and choose [RC] (remote control).

- "Flash" (P. 28)

4 Take a test shot to check the operation of the flash and the resulting image.

- Be sure to check the charge level of the camera and wireless flash before taking pictures.
- When the camera flash is set to [RC], the camera built-in flash is used for communication with the wireless flash. It cannot be used for taking pictures.
- To take pictures with a wireless flash, point the remote sensor of the special external flash toward the camera, and point the flash in the direction of the subject.

Using Optional Converters and Other Accessories

A fish eye converter capable of shooting pictures with strongly emphasized perspective and the unique facial expressions of pets etc. and a teleconverter capable of shooting faraway scenes are available.

When shooting with MACROs, you can use the LED light guide to prevent unevenness in the MACRO LED illumination. The dedicated FD-1 flash diffuser allows the flash to be used in  (Microscope mode) or whenever pictures are taken at short ranges.

Conversion lens/LED light guide/ Protective filter/Flash diffuser	Converter adapter
Fish Eye converter (FCON-T01)	CLA-T01
Teleconverter (TCON-T01)	
Protective filter (PRF-D40.5 PRO)	
LED light guide (LG-1)	—
Flash diffuser (FD-1)	—

- Rinse the product with fresh water after underwater use.
- The LED light guide cannot be used underwater.

To attach/remove the lens ring

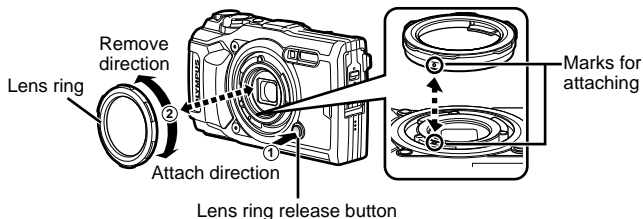

To attach/remove the LED light guide

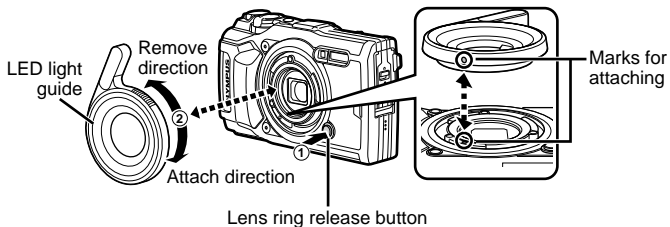

- When the LED light guide is installed, do not fire the flash.

To attach/remove the conversion lens/protective filter

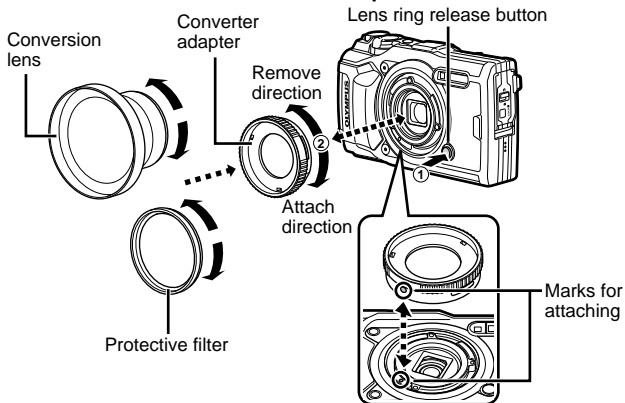

To attach/remove the flash diffuser

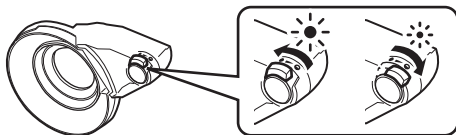
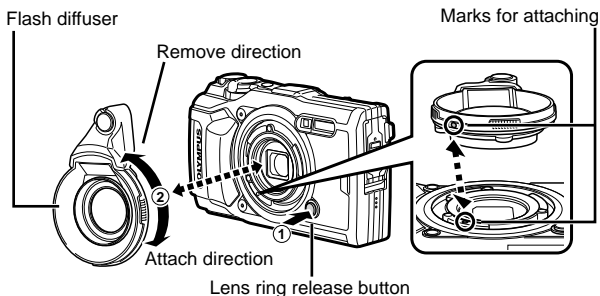

- To attach a lens ring, converter adapter, LED light guide, or diffuser, align the mounting marks and rotate the accessory in the “attach direction” until it clicks into place.
- For details, please visit the Olympus website for your local area.

Important information about water and shock resistant features

Water resistance: The waterproof feature is warranted*1 to operate at depths up to 15 m (49.2 feet) for up to one hour.

The waterproof feature may be compromised if the camera is subject to substantial or excessive impact.

Shock resistance: The anti-shock feature warrants*2 the operation of the camera against accidental impact incurred from everyday use of your digital compact camera. The anti-shock feature does not unconditionally warrant all defective operation or cosmetic damage. Cosmetic damage, such as scratches and dents, are not covered under the warranty.

As with any electronic device, proper care and maintenance are required to preserve the integrity and operation of your camera. To maintain camera performance, please take your camera to the nearest Olympus Authorized Service Center to have it inspected after any major impact. In the event the camera is damaged as a result of negligence or misuse, the warranty will not cover costs associated with the service or repair of your camera. For additional information on our warranty, please visit to the Olympus website for your local area.

Please observe the following care instructions for your camera.

- *1 As determined by Olympus pressure testing equipment in accordance with IEC Standard Publication 60529 IPX8 - This means that the camera can be used normally under water at a specified water pressure.
- *2 This anti-shock performance is confirmed by Olympus' testing conditions in accordance with MIL-STD-810F, Method 516.5, Procedure IV (Transit Drop Test). For more details of Olympus' testing conditions, please refer to the Olympus website for your local area.

Before Use:

- Check the camera for foreign material including dirt, dust or sand.
- Firmly close the battery/card compartment cover lock, connector cover lock and LOCK knob.
- Do not open the battery/card compartment cover and connector cover with wet hands, while under water, or in a damp or dusty environment (e.g. beach).

After Use:

- Be sure to wipe off any excess water or debris after using the camera under water.
- **After the camera is used under seawater, immerse the camera in a bucket containing fresh water for about 10 minutes (with the battery/card compartment cover and connector cover firmly closed, the lock in place and the lens ring removed). After that, let the camera dry in a shaded location with good ventilation.**
- **When opening the battery/card compartment cover or connector cover, open slowly with the camera orientated as shown in the following illustration to prevent water drops entering the camera. If any water drops are found on the inner side of the cover, be sure to wipe them off before using the camera.**

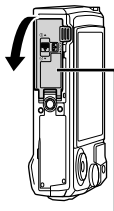





Battery/card compartment cover

Storage and Maintenance

- Do not leave the camera in an environment at high temperature (40°C (104°F) or more) or at low temperature (-10°C (14°F) or less). Failure to do so may break down water resistance.
- Do not use chemicals for cleaning, rust prevention, anti-fogging, repairing, etc. Failure to do so may break down water resistance.
- **Do not leave the camera in water for a long time. Prolonged exposure to water will cause damage to the camera's appearance and/or deteriorate water resistance.**
- **In order to preserve the water resistant feature, as with any underwater housing, it is recommended that the waterproof packing (and seals) are replaced annually.**
For the Olympus distributors or service stations where the waterproof packing can be replaced, visit Olympus website for your local area.
- The included accessories (e.g. USB-AC adapter) do not offer shock or water resistance.







List of settings available in each shooting mode

For information on **SCN**, , and , see “List of  settings” (P. 112), “List of **SCN** settings” (P. 114), and “List of  settings” (P. 113).

		P	A				
						Focus BKT	
Exposure Comp.	—	✓	✓	✓	✓	✓	✓
Picture Mode	—	✓	✓	✓	*1	*1	✓
ISO	—	✓	✓	✓	✓	✓	✓
White balance	—	✓	✓	✓	✓	✓	✓
AF Mode	—	✓	✓	✓	✓	✓	✓
Aspect	✓	✓	✓	✓	✓	✓	—
Image quality (still images)	✓	✓	✓	✓	*1	✓	✓
Record mode (movies)	*1	*1	*1	*1	*1	*1	*1
Flash	*1	✓	✓	*1	*1	*1	*1
Flash Compensation	—	✓	✓	✓	✓	✓	✓
Image stabilizer (still images)	—	✓	✓	✓	✓	✓	✓
Image stabilizer (movies)	—	—	—	—	—	—	—
 /🔄	*1	✓	✓	✓	*1	*1	✓
Metering mode	—	✓	✓	✓	✓	✓	✓
Face priority	—	✓	✓	—	—	—	—
Accessory	*1	✓	✓	*1	*1	*1	*1
Reset/Assign Custom Modes	✓	✓	✓	✓	✓	✓	✓
AF Area	✓	✓	✓	—	—	—	—
AF Illuminator	✓	✓	✓	✓	✓	✓	✓
Intrvl. Sh./Time Lapse	—	✓	✓	✓	—	—	✓
Focus BKT	—	✓	✓	—	—	—	—
Movie 	✓	✓	✓	✓	✓	✓	✓
Recording Volume	✓	✓	✓	✓	✓	✓	✓
Video Frame Rate	✓	✓	✓	✓	✓	✓	✓
Video Bit Rate	✓	✓	✓	✓	✓	✓	✓







*1 Some functions cannot be set.

List of settings

			
Exposure Comp.	✓	✓	✓
Picture Mode	✓	*1	*1
ISO	—	—	—
White balance	✓	✓	✓
AF Mode	✓	✓	✓
Aspect	—	—	—
Image quality (still images)	✓	✓	✓
Record mode (movies)	*1	*1	*1
Flash	—	—	—
Flash Compensation	—	—	—
Image stabilizer (still images)	—	—	—
Image stabilizer (movies)	✓	✓	—
 / 	*1	*1	*1
Metering mode	—	—	—
Face priority	✓	✓	—
Accessory	*1	*1	*1
Reset/Assign Custom Modes	*1	*1	*1
AF Area	✓	✓	✓
AF Illuminator	✓	✓	✓
Intrvl. Sh./Time Lapse	—	—	—
Focus BKT	—	—	—
Movie 	✓	✓	—
Recording Volume	✓	✓	—
Video Frame Rate	✓	✓	—
Video Bit Rate	✓	—	—

*1 Some functions cannot be set.

List of settings









				
Exposure Comp.	✓	✓	✓	✓
Picture Mode	—	—	—	—
ISO	—	—	—	—
White balance	✓	✓	✓	✓
AF Mode	✓	✓	✓	✓
Aspect	✓	✓	✓	✓
Image quality (still images)	✓	✓	✓	*1
Record mode (movies)	*1	*1	*1	*1
Flash	*1	*1	*1	—
Flash Compensation	✓	✓	✓	—
Image stabilizer (still images)	✓	✓	✓	✓
Image stabilizer (movies)	—	—	—	—
 /🕒	*1	*1	*1	—
Metering mode	—	—	—	—
Face priority	—	—	—	—
Accessory	*1	*1	*1	*1
Reset/Assign Custom Modes	✓	✓	✓	✓
AF Area	✓	✓	✓	✓
AF Illuminator	✓	✓	✓	✓
Intrvl. Sh./Time Lapse	—	—	—	—
Focus BKT	—	—	—	—
Movie 	✓	✓	✓	✓
Recording Volume	✓	✓	✓	✓
Video Frame Rate	✓	✓	✓	✓
Video Bit Rate	✓	✓	✓	✓

*1 Some functions cannot be set.

List of SCN settings

Exposure Comp.	—	✓	—	—	—	—	—	—	—	—	—
Picture Mode	—	—	—	—	—	—	—	—	—	—	—
ISO	—	—	—	—	—	—	—	—	—	—	—
White balance	—	—	—	—	—	—	—	—	—	—	—
AF Mode	—	—	—	—	—	—	—	—	—	—	—
Aspect	✓	✓	✓	✓	✓	✓	✓	✓	✓	✓	✓
Image quality (still images)	✓	*1	✓	✓	✓	✓	*1	✓	✓	✓	✓
Record mode (movies)	*1	*1	*1	*1	*1	*1	*1	*1	*1	*1	*1
Flash	*1	*1	*1	*1	*1	—	—	—	—	*1	*1
Flash Compensation	—	—	—	—	—	—	—	—	—	—	—
Image stabilizer (still images)	✓	✓	✓	✓	✓	✓	✓	✓	—	✓	✓
Image stabilizer (movies)	—	—	—	—	—	—	—	—	—	—	—
	*1	*1	*1	*1	*1	*1	—	*1	—	*1	*1
Metering mode	—	—	—	—	—	—	—	—	—	—	—
Face priority	✓	✓	✓	✓	✓	—	—	—	—	✓	—
Accessory	*1	*1	*1	*1	*1	*1	*1	*1	*1	*1	*1
Reset/Assign Custom Modes	✓	✓	✓	✓	✓	✓	✓	✓	✓	✓	✓
AF Area	✓	✓	✓	✓	✓	✓	✓	—	✓	✓	✓
AF Illuminator	✓	✓	✓	✓	✓	✓	✓	✓	✓	✓	✓
Intrvl. Sh./Time Lapse	—	—	—	—	—	—	—	—	—	—	—
Focus BKT	—	—	—	—	—	—	—	—	—	—	—
Movie	✓	—	✓	✓	✓	✓	—	✓	—	✓	✓
Recording Volume	✓	—	✓	✓	✓	✓	—	✓	—	✓	✓
Video Frame Rate	✓	✓	✓	✓	✓	✓	✓	✓	✓	✓	✓
Video Bit Rate	✓	✓	✓	✓	✓	✓	✓	✓	✓	✓	✓

*1 Some functions cannot be set.

					
Exposure Comp.	—	—	✓	—	—
Picture Mode	—	—	—	—	—
ISO	—	—	—	—	—
White balance	—	—	✓	—	—
AF Mode	—	—	—	—	—
Aspect	✓	✓	—	✓	✓
Image quality (still images)	✓	✓	—	*1	✓
Record mode (movies)	*1	*1	*1	*1	*1
Flash	—	*1	—	—	—
Flash Compensation	—	—	—	—	—
Image stabilizer (still images)	✓	✓	✓	✓	✓
Image stabilizer (movies)	—	—	—	—	—
 / 	*1	*1	—	—	*1
Metering mode	—	—	—	—	—
Face priority	—	—	—	—	—
Accessory	*1	*1	*1	*1	*1
Reset/Assign Custom Modes	✓	✓	✓	✓	✓
AF Area	✓	✓	*1	*1	✓
AF Illuminator	✓	✓	✓	✓	✓
Intrvl. Sh./Time Lapse	—	—	—	—	—
Focus BKT	—	—	—	—	—
Movie 	✓	✓	—	—	✓
Recording Volume	✓	✓	—	—	✓
Video Frame Rate	✓	✓	✓	✓	✓
Video Bit Rate	✓	✓	✓	✓	✓

*1 Some functions cannot be set.



Menu directory

*1 Items that can be stored in [Custom Mode C1] or [Custom Mode C2].

*2 Default can be restored by selecting [Full] for [Reset].

*3 Default can be restored by selecting [Basic] for [Reset].



Shooting Menu 1

Function	Default	*1	*2	*3	
Reset/Assign Custom Modes	—	—	✓	—	P.52
Picture Mode	Natural	✓	✓	✓	P.53
AF Area	[]	✓	✓	✓	P.53
AF Illuminator	Off	✓	✓	✓	P.53





Shooting Menu 2

Function	Default	*1	*2	*3	
Intrvl. Sh./Time Lapse	Off	—	✓	✓	P.54
Number of Frames	99	—	✓	✓	
Start Waiting Time	00:00:01	—	✓	✓	
Interval Length	00:00:01	—	✓	✓	
Time Lapse Movie	Off	—	✓	✓	
Movie Settings					
Movie Resolution	FullHD	—	✓	✓	
Frame Rate	10fps	—	✓	✓	
Focus BKT	Off	✓	✓	✓	P.55
Set number of shots	30	✓	✓	✓	
Set focus differential	Normal	✓	✓	✓	





Video Menu

Function	Default	*1	*2	*3	
Movie 	On	—	✓	—	P.55
Recording Volume	0	—	✓	—	P.55
Video Frame Rate	30p	—	✓	—	P.55
Video Bit Rate	Fine	—	✓	—	P.56



Playback Menu

Function	Default	*1	*2	*3	
					
Start	—	—	—	—	P.56
BGM	Party Time	—	✓	✓	
Slide	All	—	✓	✓	
Slide Interval	3 sec	—	✓	—	
Movie Interval	Short	—	✓	—	
	On	—	✓	✓	P.57
Edit					
Sel. Image					
RAW Data Edit	—	✓	✓	✓	P.57
JPEG Edit	—	—	—	—	
Movie Edit	—	—	—	—	
	—	—	—	—	
Image Overlay	—	—	—	—	
Print Order	—	—	—	—	P.86
Reset Protect	—	—	—	—	P.60
Connection to Smartphone	—	—	✓	—	P.72





Custom Menu

Function	Default	*1	*2	*3	
A. MF					
MF Assist					
Magnify	Off	✓	✓	—	P.61
Peaking	Off	✓	✓	—	
B1. Disp/■)/PC					
 /Info Settings					
 Info	Image Only, Overall	✓	✓	✓	P.62
LV-Info	Custom1, Custom2	✓	✓	✓	
 Settings	25, Calendar	✓	✓	—	
Live View Boost	Off	✓	✓	✓	P.62
Flicker reduction	Auto	✓	✓	—	P.62

Function		Default	*1	*2	*3	
Displayed Grid	Off	✓	✓	—	P.63	
Peaking Color	White	✓	✓	—	P.63	
B2. Disp(■)/PC						
■))	3	✓	✓	✓	P.63	
HDMI						
Output Size	1080p	—	✓	—	P.63	
HDMI Control	Off	—	✓	—		
C. Exp/ISO						
Exposure Shift						
	±0	✓	✓	—	P.64	
		✓	✓	—		
ISO-Auto Set	High Limit: 1600 Default: 100	✓	✓	✓	P.64	
Noise Filter	Standard	✓	✓	✓	P.64	
Noise Reduct.	Auto	✓	✓	✓	P.64	
D. Custom						
	Off	✓	✓	✓	P.65	
+WB	WB AUTO	✓	✓	—	P.65	
E. /WB/Color						
Set	-1 L F, -2 L N, -3 M N, -4 S N	✓	✓	✓	P.65	
WB	WB AUTO A±0, G±0	✓	✓	—	P.66	
WB AUTO Keep Warm Color	On	✓	✓	✓	P.66	
Color Space	sRGB	✓	✓	✓	P.66	
F. Record						
File Name	Reset	—	✓	—	P.67	
Edit Filename	—	—	✓	—	P.67	
Copyright Settings						
Copyright Info.	Off	—	✓	—	P.67	
Artist Name	—	—	—	—		
Copyright Name	—	—	—	—		

Function	Default	*1	*2	*3	
G. Field Sensor					
Elevation / Depth	—	—	✓	—	P.68
Record GPS location	Off	—	✓	—	P.68
GPS Priority	GPS accuracy	—	✓	✓	P.68
H.  Utility					
Pixel Mapping	—	—	—	—	P.68
Level Adjust	—	—	✓	—	P.69
Sleep	1 min	—	✓	✓	P.69
Eye-Fi	On	—	✓	—	P.69
Certification	—	—	—	—	P.69

Setup Menu

Function	Default	*1	*2	*3	
Card Setup	—	—	—	—	P.70
 Settings	—	—	—	—	P.70
 *	—	—	—	—	P.71
	±0	—	✓	—	P.71
Rec View	0.5 sec	✓	✓	—	P.71
Wi-Fi Settings					
Wi-Fi Connect Settings	Private	—	✓	—	P.71
Private Password	—	—	—	—	
Reset share Order	—	—	—	—	
Reset Wi-Fi Settings	—	—	—	—	

* Settings differ depending on the region where the camera is purchased.

SAFETY PRECAUTIONS



CAUTION

**RISK OF ELECTRICAL SHOCK
DO NOT OPEN**



CAUTION: TO REDUCE THE RISK OF ELECTRICAL SHOCK, DO NOT REMOVE COVER (OR BACK). NO USER-SERVICEABLE PARTS INSIDE. REFER SERVICING TO QUALIFIED OLYMPUS SERVICE PERSONNEL.



An exclamation mark enclosed in a triangle alerts you to important operating and maintenance instructions in the documentation provided with the product.



WARNING

If the product is used without observing the information given under this symbol, serious injury or death may result.



CAUTION

If the product is used without observing the information given under this symbol, injury may result.



NOTICE

If the product is used without observing the information given under this symbol, damage to the equipment may result.

WARNING!

TO AVOID THE RISK OF FIRE OR ELECTRICAL SHOCK, NEVER DISASSEMBLE THIS PRODUCT.

General Precautions

Read All Instructions — Before you use the product, read all operating instructions. Save all manuals and documentation for future reference.

Water and Moisture — For precautions on products with weatherproof designs, read the weatherproofing sections.

Power Source — Connect this product only to the power source described on the product label.

Foreign Objects — To avoid personal injury, never insert a metal object into the product.

Cleaning — Always unplug this product from the wall outlet before cleaning. Use only a damp cloth for cleaning.

Never use any type of liquid or aerosol cleaner, or any type of organic solvent to clean this product.

Heat — Never use or store this product near any heat source such as a radiator, heat register, stove, or any type of equipment or appliance that generates heat, including stereo amplifiers.

Lightning — If a lightning storm occurs while using a USB-AC adapter, remove it from the wall outlet immediately.

Attachments — For your safety, and to avoid damaging the product, use only accessories recommended by Olympus.

Location — To avoid damage to the product, mount the product securely on a stable tripod, stand, or bracket.



WARNING

- Do not use the camera near flammable or explosive gases.
- Do not use the flash and LED (including AF illuminator) on people (infants, small children, etc.) at close range.
 - You must be at least 1 m (3 ft.) away from the faces of your subjects. Firing the flash too close to the subject's eyes could cause a momentary loss of vision.
- Do not look at the sun or strong lights with the camera.

- **Keep young children and infants away from the camera.**
 - Always use and store the camera out of the reach of young children and infants to prevent the following dangerous situations which could cause serious injury:
 - Becoming entangled in the camera strap, causing strangulation.
 - Accidentally swallowing the battery, cards or other small parts.
 - Accidentally firing the flash into their own eyes or those of another child.
 - Accidentally being injured by the moving parts of the camera.
- **If you find that the USB-AC adapter is extremely hot or notice any unusual odors, noise, or smoke around it, unplug the power plug from wall outlet immediately and stop using it. Then, contact an authorized distributor or service center.**
- **Stop using the camera immediately if you notice any unusual odors, noise, or smoke around it.**
 - Never remove the batteries with bare hands, which may cause a fire or burn your hands.
- **Do not leave the camera in places where it may be subject to extremely high temperatures.**
 - Doing so may cause parts to deteriorate and, in some circumstances, cause the camera to catch fire. Do not use the charger or USB-AC adapter if it is covered (such as a blanket). This could cause overheating, resulting in fire.
- **Handle the camera with care to avoid getting a low-temperature burn.**
 - When the camera contains metal parts, overheating can result in a low-temperature burn. Pay attention to the following:
 - When used for a long period, the camera will get hot. If you hold on to the camera in this state, a low-temperature burn may be caused.
 - In places subject to extremely cold temperatures, the temperature of the camera's body may be lower than the environmental temperature. If possible, wear gloves when handling the camera in cold temperatures.
- To protect the high-precision technology contained in this product, never leave the camera in the places listed below, no matter if in use or storage:
 - Places where temperatures and/or humidity are high or go through extreme changes. Direct sunlight, beaches, locked cars, or near other heat sources (stove, radiator, etc.) or humidifiers.
 - In sandy or dusty environments.
 - Near flammable items or explosives.
 - In wet places, such as bathrooms or in the rain. When using products with weatherproof designs, read their manuals as well.
 - In places prone to strong vibrations.
- **The camera uses a lithium ion battery specified by Olympus.**

Charge the battery with the specified USB-AC adapter or charger. Do not use any other USB-AC adapters or chargers.
- **Never incinerate or heat batteries in microwaves, on hot plates, or in pressure vessels, etc.**
- **Never leave the camera on or near electromagnetic devices.**

This may cause overheating, burning, or exploding.
- **Do not connect terminals with any metallic objects.**
 - Take precautions when carrying or storing batteries to prevent them from coming into contact with any metal objects such as jewelry, pins, fasteners, keys, etc.

The short circuit may cause overheating, exploding, or burning, which burn or damage you.
- **To prevent causing battery leaks or damaging their terminals, carefully follow all instructions regarding the use of batteries. Never attempt to disassemble a battery or modify it in any way, solder, etc.**
- **If battery fluid gets into your eyes, flush your eyes immediately with clear, cold running water and seek medical attention immediately.**
- **If you cannot remove the battery from the camera, contact an authorized distributor or service center.**

Do not try to remove the battery by force. Damage to the battery exterior (scratches, etc.) may produce heat or an explosion.
- **Always store batteries out of the reach of small children and pets. If they accidentally swallow a battery, seek medical attention immediately.**
 - To prevent batteries from leaking, overheating, or causing a fire or explosion, use only batteries recommended for use with this product.
 - If rechargeable batteries have not been recharged within the specified time, stop charging them and do not use them.
 - Do not use batteries with scratches or damage to the casing, and do not scratch the battery.

- Never subject batteries to strong shocks or continuous vibration by dropping or hitting. This may cause exploding, overheating, or burning.
- If a battery leaks, has unusual odor, becomes discolored or deformed, or becomes abnormal in any other way during operation, stop using the camera, and keep away from fire immediately.
- If a battery leaks fluid onto your clothing or skin, remove the clothing and flush the affected area with clean, running cold water immediately. If the fluid burns your skin, seek medical attention immediately.
- The Olympus lithium ion battery is designed to be used only for the Olympus digital camera. Do not use the battery to other devices.
- **Do not allow children or animals/pets to handle or transport batteries (prevent dangerous behaviour such as licking, putting in mouth or chewing).**

Use Only Dedicated Rechargeable Battery, Battery Charger and USB-AC adapter

We strongly recommend that you use only the genuine Olympus dedicated rechargeable battery, battery charger and USB-AC adapter with this camera. Using a non-genuine rechargeable battery, battery charger and/or USB-AC adapter may result in fire or personal injury due to leakage, heating, ignition or damage to the battery. Olympus does not assume any liability for accidents or damage that may result from the use of a battery, battery charger and/or USB-AC adapter that are not genuine Olympus accessories.

CAUTION

- The included USB-AC adapter F-5AC is designed to be used only with this camera. Other cameras cannot be charged with this USB-AC adapter.
- Do not connect the included USB-AC adapter F-5AC to equipment other than this camera.
- **Never store batteries where they will be exposed to direct sunlight, or subjected to high temperatures in a hot vehicle, near a heat source, etc.**
- Keep batteries dry at all times.
- The battery may become hot during prolonged use. To avoid minor burns, do not remove it immediately after using the camera.
- This camera uses one Olympus lithium ion battery. Use the specified genuine battery. There is a risk of explosion if the battery is replaced with the incorrect battery type.
- Please recycle batteries to help save our planet's resources. When you throw away dead batteries, be sure to cover their terminals and always observe local laws and regulations.
- **Do not cover the flash with a hand while firing.**

NOTICE

- **Do not use or store the camera in dusty or humid places.**
- **Use SD/SDHC/SDXC memory cards or Eye-Fi cards only. Never use other types of cards.**
If you accidentally insert another type of card into the camera, contact an authorized distributor or service center. Do not try to remove the card by force.
- Regularly back up important data to a computer or other storage device to prevent accidental loss.
- OLYMPUS accepts no liability for any loss of data associated with this device.
- Be careful with the strap when you carry the camera. It could easily catch on stray objects and cause serious damage.
- Never drop the camera or subject it to severe shocks or vibrations.
- When attaching the camera to or removing it from a tripod, rotate the tripod screw, not the camera.
- Before transporting the camera, remove a tripod and all other non-OLYMPUS accessories.
- Do not touch electric contacts on cameras.
- Do not leave the camera pointed directly at the sun. This may cause lens or shutter curtain damage, color failure, ghosting on the image pickup device, or may possibly cause fires.
- Do not push or pull severely on the lens.
- Before storing the camera for a long period, remove the batteries. Select a cool, dry location for storage to prevent condensation or mold from forming inside the camera. After storage, test the camera by turning it on and pressing the shutter button to make sure that it is operating normally.
- The camera may malfunction if it is used in a location where it is subject to a magnetic/electromagnetic field, radio waves, or high voltage, such as near a TV set, microwave, video game, loud speakers, large monitor unit, TV/radio tower, or transmission towers. In such cases, turn the camera off and on again before further operation.

- Always observe the operating environment restrictions described in the camera's manual.
- Insert the battery carefully as described in the operating instructions.
- Before loading, always inspect the battery carefully for leaks, discoloration, warping, or any other abnormality.
- Always unload the battery from the camera before storing the camera for a long period.
- When storing the battery for a long period, select a cool location for storage.
- Power consumption by the camera varies depending on which functions are used.
- During the conditions described below, power is consumed continuously and the battery becomes exhausted quickly.
 - The zoom is used repeatedly.
 - The shutter button is pressed halfway repeatedly in shooting mode, activating the auto focus.
 - A picture is displayed on the monitor for an extended period of time.
 - The camera is connected to a printer.
 - GPS is used.
- Using an exhausted battery may cause the camera to turn off without displaying the battery level warning.
- If the battery's terminals get wet or greasy, camera contact failure may result. Wipe the battery well with a dry cloth before use.
- Always charge a battery when using it for the first time, or if it has not been used for a long period.
- When operating the camera with battery power at low temperatures, try to keep the camera and spare battery as warm as possible. A battery that has run down at low temperatures may be restored after it is warmed at room temperature.
- Before going on a long trip, and especially before traveling abroad, purchase extra batteries. A recommended battery may be difficult to obtain while traveling.
- For plug-in type USB-AC adapter:
Connect the plug-in type USB-AC adapter F-5AC correctly by plugging it vertically into the wall outlet.

Using the wireless LAN function

- **Turn off the camera in hospitals and other locations where medical equipment is present.**

The radio waves from the camera may adversely affect medical equipment, causing a malfunction that results in an accident.

- **Turn off the camera when onboard aircraft.**

Using wireless devices onboard may hinder safe operation of the aircraft.

Precautions when using the wireless LAN function

If using the wireless LAN function in a country outside the region where the camera was purchased, there is a risk that the camera will not conform to the wireless communication regulations of that country. Olympus will not be held responsible for any failure to meet such regulations.

GPS function, electronic compass

- In a location not open to the sky (inside, underground, underwater, in a forest, near high buildings) or in a location subject to strong magnetic or electric fields (near new high-voltage power lines, magnets or electrical goods, 1.5GHz mobile telephones), it may not be possible to determine measurements or generate errors.
- The altitude displayed on the measurement information screen or picture playback screen etc. is displayed/recorded based on information from pressure sensors built into camera body. Be careful since the displayed altitude is not based on GPS position measurements.
- Electronic compass errors may be caused by the effects of strong magnetic or electrical fields (such as televisions, microwaves, large motors, radio towers and high-voltage lines). To restore the electronic compass function, hold the camera firmly and move in a figure of 8 while turning your wrist over.
- Since the GPS function and electronic compass function are not required to be accurate, there is no guarantee that the measured values (latitude, longitude, compass direction etc.) are accurate.

Monitor

- Do not push the monitor forcibly; otherwise the image may become vague, resulting in a playback mode failure or damage to the monitor.
- A strip of light may appear on the top/bottom of the monitor, but this is not a malfunction.
- When a subject is viewed diagonally in the camera, the edges may appear zigzagged on the monitor. This is not a malfunction; it will be less noticeable in playback mode.

- In places subject to low temperatures, the monitor may take a long time to turn on or its color may change temporarily. When using the camera in extremely cold places, it is a good idea to occasionally place it in a warm place. The monitor exhibiting poor performance due to low temperatures will recover in normal temperatures.
- The monitor of this product is manufactured with high-quality accuracy, however, there may be a stuck or dead pixel on the monitor. These pixels do not have any influence on the image to be saved. Because of the characteristics, the unevenness of the color or brightness may also be found depending on the angle, but this is due to the structure of the monitor. This is not a malfunction.

Legal and Other Notices

- Olympus makes no representations or warranties regarding any damages, or benefit expected by using this unit lawfully, or any request from a third person, which are caused by the inappropriate use of this product.
- Olympus makes no representations or warranties regarding any damages or any benefit expected by using this unit lawfully which are caused by erasing picture data.

Disclaimer of Warranty

- Olympus makes no representations or warranties, either expressed or implied, by or concerning any content of these written materials or software, and in no event shall be liable for any implied warranty of merchantability or fitness for any particular purpose or for any consequential, incidental or indirect damages (including but not limited to damages for loss of business profits, business interruption and loss of business information) arising from the use or inability to use these written materials or software or equipment. Some countries do not allow the exclusion or limitation of liability for consequential or incidental damages or of the implied warranty, so the above limitations may not apply to you.
- Olympus reserves all rights to this manual.

Warning

Unauthorized photographing or use of copyrighted material may violate applicable copyright laws. Olympus assumes no responsibility for unauthorized photographing, use or other acts that infringe upon the rights of copyright owners.

Copyright Notice

All rights reserved. No part of these written materials or this software may be reproduced or used in any form or by any means, electronic or mechanical, including photocopying and recording or the use of any type of information storage and retrieval system, without the prior written permission of Olympus. No liability is assumed with respect to the use of the information contained in these written materials or software, or for damages resulting from the use of the information contained therein. Olympus reserves the right to alter the features and contents of this publication or software without obligation or advance notice.

FCC Notice

This equipment has been tested and found to comply with the limits for a Class B digital device, pursuant to part 15 of the FCC Rules. These limits are designed to provide reasonable protection against harmful interference in a residential installation. This equipment generates, uses and can radiate radio frequency energy and, if not installed and used in accordance with the instructions, may cause harmful interference to radio communications. However, there is no guarantee that interference will not occur in a particular installation. If this equipment does cause harmful interference to radio or television reception, which can be determined by turning the equipment off and on, the user is encouraged to try to correct the interference by one or more of the following measures:

- Reorient or relocate the receiving antenna.
- Increase the separation between the equipment and receiver.
- Connect the equipment into an outlet on a circuit different from that to which the receiver is connected.
- Consult the dealer or an experienced radio/TV technician for help.
- Only the OLYMPUS-supplied USB cable should be used to connect the camera to USB enabled personal computers.

FCC/IC Caution

Changes or modifications not expressly approved by the party responsible for compliance could void the user's authority to operate the equipment.

This transmitter must not be co-located or operated in conjunction with any other antenna or transmitter.

This equipment complies with FCC radiation exposure limits set forth for an uncontrolled environment and meets the FCC radio frequency (RF) Exposure Guidelines. This equipment has very low levels of RF energy that are deemed to comply without testing of specific absorption rate (SAR).

The available scientific evidence does not show that any health problems are associated with using low power wireless devices. There is no proof, however, that these low power wireless devices are absolutely safe. Low power Wireless devices emit low levels of radio frequency energy (RF) in the microwave range while being used. Whereas high levels of RF can produce health effects (by heating tissue), exposure of low-level RF that does not produce heating effects causes no known adverse health effects. Many studies of low-level RF exposures have not found any biological effects. Some studies have suggested that some biological effects might occur, but such findings have not been confirmed by additional research. IM005 has been tested and found to comply with IC radiation exposure limits set forth for an uncontrolled environment and meets RSS-102 of the IC radio frequency (RF) Exposure rules.

For customers in North America, Central America, South America and the Caribbean

Declaration of Conformity

Model Number:	IM005
Trade Name:	OLYMPUS
Responsible Party:	OLYMPUS AMERICA INC.
Address:	3500 Corporate Parkway, P.O. Box 610, Center Valley, PA 18034-0610, U.S.A.
Telephone Number:	484-896-5000

Tested To Comply With FCC Standards

FOR HOME OR OFFICE USE

This device complies with Part 15 of FCC Rules and Industry Canada licence-exempt RSS standard(s). Operation is subject to the following two conditions:

- (1) This device may not cause harmful interference.
- (2) This device must accept any interference received, including interference that may cause undesired operation.

This Class B digital apparatus complies with Canadian ICES-003. CAN ICES-3(B)/NMB-3(B)

OLYMPUS AMERICAS LIMITED WARRANTY - OLYMPUS AMERICA INC. PRODUCTS

Olympus warrants that the enclosed Olympus® imaging product(s) and related Olympus® accessories (individually a "Product" and collectively the "Products") will be free from defects in materials and workmanship under normal use and service for a period of one (1) year from the date of purchase.

If any Product proves to be defective within the one-year warranty period, the customer must return the defective Product to the authorized Olympus Repair Service Center designated by Olympus, following the procedure set forth below (See "WHAT TO DO WHEN SERVICE IS NEEDED").

Olympus, at its sole discretion, will repair, replace, or adjust the defective Product at Olympus's cost, provided that an Olympus investigation and factory inspection disclose that (a) such defect developed under normal and proper use and (b) the Product is covered under this limited warranty.

Repair, replacement, or adjustment of defective Products shall be Olympus's sole obligation and the customer's sole remedy hereunder.

Repair or replacement of a Product shall not extend the warranty period provided herein, unless required by law. Except where prohibited by law, the customer is liable and shall pay for shipment of the Products to the designated Olympus Repair Service Center.

Olympus shall not be obligated to perform preventive maintenance, installation, deinstallation, or maintenance.

Olympus reserves the right to (i) use reconditioned, refurbished, and/or serviceable used parts (that meet Olympus's quality assurance standards) for warranty or any other repairs and (ii) make any internal or external design and/or feature changes on or to its products without any liability to incorporate such changes on or to the Products.

WHAT IS NOT COVERED BY THIS LIMITED WARRANTY

Excluded from this limited warranty and not warranted by Olympus in any fashion, either express, implied, or by statute, are:

- (a) products and accessories not manufactured by Olympus and/or not bearing the "OLYMPUS" brand label (the warranty coverage for products and accessories of other manufacturers, which may be distributed by Olympus, is the responsibility of the respective manufacturer of such products and accessories in accordance with the terms and duration of such manufacturers' warranties);
- (b) any Product which has been disassembled, repaired, tampered with, altered, changed, or modified by persons other than Olympus's own authorized service personnel unless repair by others is made with the written consent of Olympus;
- (c) defects or damage to the Products resulting from wear, tear, misuse, abuse, negligence, sand, liquids, impact, improper storage, nonperformance of scheduled operator and maintenance items, battery leakage, use of non-"OLYMPUS" brand accessories, consumables, or supplies, or use of the Products in combination with non-compatible devices;
- (d) software programs;
- (e) supplies and consumables (including but not limited to lamps, ink, paper, film, prints, negatives, cables and batteries); and/or
- (f) Products which do not contain a validly placed and recorded Olympus serial number, unless they are a model on which Olympus does not place and record serial numbers.
- (g) Products shipped, delivered, purchased, or sold from dealers located outside of North America, Central America, South America and the Caribbean; and/or
- (h) Products that are not intended or authorized to be sold in North America, South America, Central America, or the Caribbean (ie. Gray Market Goods).

WARRANTY DISCLAIMER; LIMITATION OF DAMAGES; AFFIRMATION OF ENTIRE WARRANTY AGREEMENT; INTENDED BENEFICIAL

EXCEPT FOR THE LIMITED WARRANTY SET FORTH ABOVE, OLYMPUS MAKES NO AND DISCLAIMS ALL OTHER REPRESENTATIONS, GUARANTIES, CONDITIONS, AND WARRANTIES CONCERNING THE PRODUCTS, WHETHER DIRECT OR INDIRECT, EXPRESS OR IMPLIED, OR ARISING UNDER ANY STATUTE, ORDINANCE, COMMERCIAL USAGE OR OTHERWISE, INCLUDING BUT NOT LIMITED TO ANY WARRANTY OR REPRESENTATION AS TO THE SUITABILITY, DURABILITY, DESIGN, OPERATION, OR CONDITION OF THE PRODUCTS (OR ANY PART THEREOF) OR THE MERCHANTABILITY OF THE PRODUCTS OR THEIR FITNESS FOR A PARTICULAR PURPOSE, OR RELATING TO THE INFRINGEMENT OF ANY PATENT, COPYRIGHT, OR OTHER PROPRIETARY RIGHT USED OR INCLUDED THEREIN.

IF ANY IMPLIED WARRANTIES APPLY AS A MATTER OF LAW, THEY ARE LIMITED IN DURATION TO THE LENGTH OF THIS LIMITED WARRANTY.

SOME STATES MAY NOT RECOGNIZE A DISCLAIMER OR LIMITATION OF WARRANTIES AND/OR LIMITATION OF LIABILITY SO THE ABOVE DISCLAIMERS AND EXCLUSIONS MAY NOT APPLY.

THE CUSTOMER MAY ALSO HAVE DIFFERENT AND/OR ADDITIONAL RIGHTS AND REMEDIES THAT VARY FROM STATE TO STATE.

THE CUSTOMER ACKNOWLEDGES AND AGREES THAT OLYMPUS SHALL NOT BE RESPONSIBLE FOR ANY DAMAGES THAT THE CUSTOMER MAY INCUR FROM DELAYED SHIPMENT, PRODUCT FAILURE, PRODUCT DESIGN, SELECTION, OR PRODUCTION, IMAGE OR DATA LOSS OR IMPAIRMENT OR FROM ANY OTHER CAUSE, WHETHER LIABILITY IS ASSERTED IN CONTRACT, TORT (INCLUDING NEGLIGENCE AND STRICT PRODUCT LIABILITY) OR OTHERWISE. IN NO EVENT SHALL OLYMPUS BE LIABLE FOR ANY INDIRECT, INCIDENTAL, CONSEQUENTIAL OR SPECIAL DAMAGES OF ANY KIND (INCLUDING WITHOUT LIMITATION LOSS OF PROFITS OR LOSS OF USE), WHETHER OR NOT OLYMPUS SHALL BE OR SHOULD BE AWARE OF THE POSSIBILITY OF SUCH POTENTIAL LOSS OR DAMAGE.

Representations and warranties made by any person, including but not limited to dealers, representatives, salespersons, or agents of Olympus, which are inconsistent or in conflict with or in addition to the terms of this limited warranty, shall not be binding upon Olympus unless reduced to writing and approved by an expressly authorized officer of Olympus.

This limited warranty is the complete and exclusive statement of warranty which Olympus agrees to provide with respect to the Products and it shall supersede all prior and contemporaneous oral or written agreements, understandings, proposals, and communications pertaining to the subject matter hereof.

This limited warranty is exclusively for the benefit of the original customer and cannot be transferred or assigned.

WHAT TO DO WHEN SERVICE IS NEEDED

The customer must contact the designated Olympus Consumer Support Team for your region to coordinate the submission of your Product for repair service. To contact your Olympus Consumer Support Team in your region please visit or call the following:

Canada:

www.olympuscanada.com/repair / 1-800-622- 6372

United States:

www.olympusamerica.com/repair / 1-800-622- 6372

Latin America:

www.olympusamericalatina.com

The customer must copy or transfer any image or other data saved on a Product to another image or data storage medium prior to sending the Product to Olympus for repair service.

IN NO EVENT SHALL OLYMPUS BE RESPONSIBLE FOR SAVING, KEEPING OR MAINTAINING ANY IMAGE OR DATA SAVED ON A PRODUCT RECEIVED BY IT FOR SERVICE, OR ON ANY FILM CONTAINED WITHIN A PRODUCT RECEIVED BY IT FOR SERVICE, NOR SHALL OLYMPUS BE RESPONSIBLE FOR ANY DAMAGES IN THE EVENT ANY IMAGE OR DATA IS LOST OR IMPAIRED WHILE SERVICE IS BEING PERFORMED (INCLUDING, WITHOUT LIMITATION, DIRECT, INDIRECT, INCIDENTAL, CONSEQUENTIAL OR SPECIAL DAMAGES, LOSS OF PROFITS OR LOSS OF USE), WHETHER OR NOT OLYMPUS SHALL BE OR SHOULD BE AWARE OF THE POSSIBILITY OF SUCH POTENTIAL LOSS OR IMPAIRMENT.

The customer should package the Product carefully using ample padding material to prevent damage in transit. Once the Product is properly packaged, ship the package to Olympus or the Olympus Authorized Repair Service Center location as instructed by the respective Olympus Consumer Support Team.

When sending Products for repair service, your package should include the following:

- 1) Sales receipt showing date and place of purchase. Handwritten receipts will not be accepted;
- 2) Copy of this limited warranty **bearing the Product serial number corresponding to the serial number on the Product** (unless it is a model on which Olympus does not place and record serial numbers);
- 3) A detailed description of the problem; and
- 4) Sample prints, negatives, digital prints (or files on disk) if available and related to the problem.

KEEP COPIES OF ALL DOCUMENTS. Neither Olympus nor an Olympus Authorized Repair Service Center will be responsible for documents that are lost or destroyed in transit.

When service is completed, the Product will be returned to you postage prepaid.

PRIVACY

Any information provided by you to process your warranty claim shall be kept confidential and will only be used and disclosed for the purposes of processing and performing warranty repair services.

For customers in Mexico

The operation of this equipment is subject to the following two conditions:

- (1) it is possible that this equipment or device may not cause harmful interference, and (2) this equipment or device must accept any interference, including interference that may cause undesired operation.

For customers in Europe

Simple Declaration of Conformity

Hereby, OLYMPUS CORPORATION declares that the radio equipment type IM005 is in compliance with Directive 2014/53/EU.

The full text of the EU declaration of conformity is available at the following internet address:
<http://www.olympus-europa.com/>



This symbol [crossed-out wheeled bin WEEE Annex IV] indicates separate collection of waste electrical and electronic equipment in the EU countries.

Please do not throw the equipment into the domestic refuse.

Please use the return and collection systems available in your country for the disposal of this product.



This symbol [crossed-out wheeled bin Directive 2006/66/EC Annex II] indicates separate collection of waste batteries in the EU countries.

Please do not throw the batteries into the domestic refuse.

Please use the return and collection systems available in your country for the disposal of the waste batteries.

Provisions of warranty

In the unlikely event that your product proves to be defective, although it has been used properly (in accordance with the written Instruction Manual supplied with it), during the applicable national warranty period and has been purchased from an authorized Olympus distributor within the business area of OLYMPUS EUROPA SE & Co. KG as stipulated on the website: <http://www.olympus-europa.com>, it will be repaired, or at Olympus's option replaced, free of charge. In order to enable Olympus to provide you with the requested warranty services to your full satisfaction and as fast as possible, please note the information and instructions listed below:

- To claim under this warranty please follow the instructions on <http://consumer-service.olympus-europa.com> for registration and tracking (this service is not available in all countries) or take the product, the corresponding original invoice or purchase receipt and the completed Warranty Certificate to the dealer where it was purchased or any other Olympus service station within the business area of OLYMPUS EUROPA SE & Co. KG as stipulated on the website: <http://www.olympus-europa.com>, before the end of the applicable national warranty period.
- Please make sure your Warranty Certificate is duly completed by Olympus or an authorized dealer or Service center. Therefore, please make sure that your name, the name of the dealer, the serial number and the year, month and date of purchase are all completed or the original invoice or the sales receipt (indicating the dealer's name, the date of purchase and product type) is attached to your Warranty Certificate.
- Since this Warranty Certificate will not be re-issued, keep it in a safe place.
- Please note that Olympus will not assume any risks or bear any costs incurred in transporting the product to the dealer or Olympus authorized service station.
- This Warranty does not cover the following and you will be required to pay a repair charge, even for defects occurring within the warranty period referred to above.
 - Any defect that occurs due to mishandling (such as an operation performed that is not mentioned in the Instruction Manual, etc.)
 - Any defect that occurs due to repair, modification, cleaning, etc. performed by anyone other than Olympus or an Olympus authorized service station.
 - Any defect or damage that occurs due to transport, a fall, shock, etc. after purchase of the product.
 - Any defect or damage that occurs due to fire, earthquake, flood damage, thunderbolt, other natural disasters, environmental pollution and irregular voltage sources.
 - Any defect that occurs due to careless or improper storage (such as keeping the product under conditions of high temperature and humidity, near insect repellents such as naphthalene or harmful drugs, etc.), improper maintenance, etc.
 - Any defect that occurs due to exhausted batteries, etc.
 - Any defect that occurs due to sand, mud, water etc. entering the inside of the product casing.
- Olympus's sole liability under this Warranty shall be limited to repairing or replacing the product. Any liability under the Warranty for indirect or consequential loss or damage of any kind incurred or suffered by the customer due to a defect of the product, and in particular any loss or damage caused to any lenses, films, other equipment or accessories used with the product or for any loss resulting from a delay in repair or loss of data, is excluded. Compelling regulations by law remain unaffected by this.

For customers in Asia

Provisions of warranty

1. If this product proves to be defective, although it has been used properly (in accordance with the written Handling Care and Operating instructions supplied with it), during a period of up to one year from the date of purchase this product will be repaired, or at Olympus's option replaced, free of charge. To claim under warranty the customer must take the product and this Warranty certificate before the end of the one year warranty period to the dealer where the product was purchased or any Olympus authorized service station listed in the instructions and request the necessary repairs.
2. The customer shall transport the product to the dealer or Olympus authorized service station at his own risk and shall be responsible for any costs incurred in transporting the product.
3. This warranty does not cover the following and the customer will be required to pay repair charge, even for defects occurring within the one year period referred to above.
 - a. Any defect that occurs due to mishandling (such as an operation performed that is not mentioned in the Handling Care or other sections of the instructions, etc.)
 - b. Any defect that occurs due to repair, modification, cleaning, etc. performed by anyone other than Olympus or an Olympus authorized service station.
 - c. Any defect or damage that occurs due to transport, a fall, shock, etc. after purchase of the product.
 - d. Any defect or damage that occurs due to fire, earthquake, flood damage, thunderbolt, other natural disasters, environmental pollution and irregular voltage sources.
 - e. Any defect that occurs due to careless or improper storage (such as keeping the product under conditions of high temperature and humidity, near insect repellents such as naphthalene or harmful drugs, etc.), improper maintenance, etc.
 - f. Any defect that occurs due to exhausted batteries, etc.
 - g. Any defect that occurs due to sand, mud, etc. entering the inside of the product casing.
 - h. When this Warranty Certificate is not returned with the product.
 - i. When any alterations whatsoever are made to the Warranty Certificate regarding the year, month and date of purchase, the customer's name, the dealer's name, and the serial number.
 - j. When proof of purchase is not presented with this Warranty Certificate.
4. This Warranty applies to the product only; the Warranty does not apply to any other accessory equipment, such as the case, strap, lens cap, batteries and battery chargers.
5. Olympus' sole liability under this warranty shall be limited to repairing or replacing the product and any liability for indirect or consequential loss or damage of any kind incurred or suffered by the customer due to a defect in the product, and in particular any loss or damage caused to any film or lenses or other equipment or accessories used with the product or for any loss resulting from delay in repair, is excluded.

For customers in Thailand

This telecommunication equipment conforms to NTC technical requirement.

For customer in Singapore

Complies with IMDA Standards DB104634

Notes;

1. This Warranty is in addition to and does not affect the customer's statutory right.
2. If you have any queries regarding this Warranty, call any of the Olympus authorized service stations listed in the instructions.

Notes regarding warranty maintenance

1. This Warranty will only be valid if the Warranty Certificate is duly completed by Olympus or the dealer. Make sure that your name, the name of the dealer, the serial number and the year, month and date of purchase are all completed.
 2. Since this Warranty Certificate will not be re-issued, keep it in a safe place.
 3. Any request for repair by a customer in same country where the product was purchased shall be subject to the terms of the warranty issued by the Olympus distributor in that country. Where the local Olympus distributor does not issue a separate warranty or where the customer is not in the country where the product was purchased the terms of this worldwide warranty shall apply.
 4. Where applicable, this Warranty is valid only in the country the product was purchased. The Olympus authorized service stations listed in this Warranty will gladly honor it.
- * Please refer to the appended list for the authorized international Olympus service network.

Disclaimer of Warranty

Olympus makes no representations or warranties, either expressed or implied, by or concerning any content if these written materials or software, and in no event shall be liable for any implied warranty of merchantability or fitness for any particular purpose or for any consequential, incidental or indirect damages (including but not limited to damages for loss of business profits, business interruption and loss of business information) arising from the use of inability to use these written materials or software. Some states do not allow the exclusion or limitation of liability for consequential or incidental damages, so the above limitations may not apply to you.

Trademarks

- Microsoft and Windows are registered trademarks of Microsoft Corporation.
- Mac is a trademark of Apple Inc.
- SDXC logo is a trademark of SD-3C, LLC.



- Eye-Fi is a registered trademark of Eye-Fi, Inc.
- Wi-Fi is a registered trademark of the Wi-Fi Alliance.
- The Wi-Fi CERTIFIED logo is a certification mark of the Wi-Fi Alliance.



- Apical logo is a registered trademark of Apical Limited.



- All other company and product names are registered trademarks and/or trademarks of their respective owners.

THIS PRODUCT IS LICENSED UNDER THE AVC PATENT PORTFOLIO LICENSE FOR THE PERSONAL AND NONCOMMERCIAL USE OF A CONSUMER TO (i) ENCODE VIDEO IN COMPLIANCE WITH THE AVC STANDARD ("AVC VIDEO") AND/OR (ii) DECODE AVC VIDEO THAT WAS ENCODED BY A CONSUMER ENGAGED IN A PERSONAL AND NON-COMMERCIAL ACTIVITY AND/OR WAS OBTAINED FROM A VIDEO PROVIDER LICENSED TO PROVIDE AVC VIDEO. NO LICENSE IS GRANTED OR SHALL BE IMPLIED FOR ANY OTHER USE. ADDITIONAL INFORMATION MAY BE OBTAINED FROM MPEG LA, L.L.C. SEE [HTTP://WWW.MPEGLA.COM](http://WWW.MPEGLA.COM)

The software in this camera may include third party software. Any third party software is subject to the terms and conditions, imposed by the owners or licensors of that software, under which software is provided to you.

Those terms and other third party software notices, if any, may be found in the software notice PDF file stored at <http://www.olympus.co.jp/en/support/img/digicamera/download/notice/notice.cfm>

- The standards for camera file systems referred to in this manual are the "Design rule for Camera File system/ DCF" standards stipulated by the Japan Electronics and Information Technology Industries Association (JEITA).

Specifications

Camera

Product type	: Digital camera (for shooting and displaying)
Recording system	
Still pictures	: Digital recording, JPEG (in accordance with Design rule for Camera File system (DCF))
Applicable standards	: Exif 2.3, Digital Print Order Format (DPOF), PictBridge
Sound with still pictures	: Wave format
Movie	: MOV H.264 linear PCM (HS120fps or HS240fps for time lapse movie)
Memory	: SD/SDHC/SDXC (supports UHS-I)/Eye-Fi card
Total no. of pixels	: Approx. 12.71 million
No. of effective pixels	: 12 million
Image pickup device	: 1/2.3" CMOS (primary color filter)
Lens	: Olympus lens 4.5 mm to 18.0 mm, f2.0 to f4.9 (Equivalent to 25 mm to 100 mm on a 35 mm film)
Photometric system	: Digital ESP metering, spot metering system
Shutter speed	: 4 to 1/2000 sec.
Shooting range	
Normal	: 0.1 m (0.3 ft.) to ∞ (W/T)
Microscope mode	: 0.01 m (0.03 ft.) to 0.3 m (1.0 ft.) (f=5.5 mm to 18.0 mm)
Monitor	: 3.0" TFT color LCD display, 460,000 dots
Connector	: Micro-USB connector/HDMI micro connector (type D)
Automatic calendar system	: 2000 up to 2099
Water resistance	
Type	: Equivalent to IEC 60529 IPX8 (under OLYMPUS test conditions), available in 15 m (49.2 ft.) deep water
Meaning	: Camera can normally be used under water at a specified water pressure.
Dust resistance	: IEC 60529 IP6X (under OLYMPUS test conditions)

Wi-Fi standard	: IEEE802.11b/g/n
GPS	
Reception frequency	: 1575.42 MHz (GPS/ Quasi-Zenith Satellites System) 1598.0625 MHz to 1605.3750 MHz (GLONASS)
Geodetic system	: WGS84
Operating environment	
Temperature	: - 10 °C to 40 °C (14 °F to 104 °F) (operation)/ - 20 °C to 60 °C (- 4 °F to 140 °F) (storage)
Humidity	: 30% - 90% (operation)/10% - 90% (storage)
Power supply	: One Olympus lithium ion battery (LI-92B) or USB-AC adapter (F-5AC)
Dimensions	: 113.0 mm (W) × 66.0 mm (H) × 31.9 mm (D) (4.5 × 2.6 × 1.3 in.) (excluding protrusions)
Weight	: 250 g (8.8 oz) (including battery and card)

Lithium ion battery (LI-92B)

Product type	: Lithium ion rechargeable battery
Model No.	: LI-92B
Standard voltage	: DC 3.6 V
Standard capacity	: 1350 mAh
Battery life	: Approx. 300 full charges (varies on usage)
Operating environment	
Temperature	: 0 °C to 40 °C (32 °F to 104 °F) (charging)

USB-AC adapter (F-5AC)

Model No.	: F-5AC-1/F-5AC-2
Power requirements	: AC 100 to 240 V (50/60 Hz)
Output	: DC 5 V, 1500 mA
Operating environment	
Temperature	: 0 °C to 40 °C (32 °F to 104 °F) (operation)/ - 20 °C to 60 °C (- 4 °F to 140 °F) (storage)

Design and specifications subject to change without notice.
Please visit our website for the latest specification.

HDMI, the HDMI Logo and High-Definition Multimedia Interface are trademarks or registered trademarks of HDMI Licensing, LLC.

HDMI™
HIGH-DEFINITION MULTIMEDIA INTERFACE

OLYMPUS KOREA CO., LTD.

Olympus Tower A, 446, Bongeunsa-ro, Gangnam-gu, Seoul, Korea, 06153

Tel. 1544-3200

E-mail: hotline.okr@olympus-ap.com

<http://www.olympus.co.kr>

OLYMPUS (MALAYSIA) Sdn Bhd

512, 5th Floor, Block D, Kelana Square 17, Jalan SS 7/26, Kelana Jaya,

47301 Petaling Jaya, Selangor, Malaysia

Tel: (603) 7806 2173

Fax: (603) 7803 7164

E-mail: service.oml@olympus-ap.com

<http://www.olympus.com.my>

OLYMPUS (Thailand) CO., LTD.

23/112 Sorachai Building, 27th Floor, Soi Sukhumvit 63 (Ekamai)

Sukhumvit road Klongton Nua, Wattana, Bangkok 10110 Thailand

Tel: 662 787 8200

E-mail: imaging.oth@olympus-ap.com

OLYMPUS

<http://www.olympus.com/>

OLYMPUS AMERICA INC.

3500 Corporate Parkway, P.O. Box 610, Center Valley, PA 18034-0610, U.S.A. Tel. 484-896-5000

Technical Support (U.S.A. / Canada)

24/7 online automated help:

<http://www.olympusamerica.com/support>

Phone customer support:

Tel. 1-800-260-1625 (Toll-free)

Our phone customer support is available from 9 am to 9 pm (Monday to Friday) ET

<http://olympusamerica.com/contactus>

Olympus software updates can be obtained at:

<http://www.olympusamerica.com/digital>

OLYMPUS EUROPA SE & CO. KG

Premises: Consumer Product Division

Wendenstrasse 14-18, 20097

Hamburg, Germany

Tel: +49 40-23 77 3-0 / Fax: +49 40-23 07 61

Goods delivery: Modul H, Willi-Bleicher Str. 36,

52353 Düren, Germany

Mailing address: Postfach 10 49 08,

20034 Hamburg, Germany

European Technical Customer Support:

Please visit our homepage <http://www.olympus-europa.com> or call our TOLL FREE NUMBER* :

00800 - 67 10 83 00

for Austria, Belgium, Denmark, Finland, France, Germany, Luxembourg, Netherlands, Norway, Poland, Portugal, Spain, Sweden, Switzerland, United Kingdom.

810-800 67 10 83 00 for Russia

800 167 777 for Czech Republic

* Please note some phone service providers do not permit access to 00800 numbers or require an additional prefix. Charges may apply here. Please contact your service provider directly for more details.

For **all** not listed European Countries and in case that you can't get connected to the above mentioned number, please make use of the following CHARGED NUMBERS **+49 40 - 237 73 899**

OLYMPUS (CHINA) CO., LTD.

Customer Support: 400-650-0303 Homepage: <http://olympus-imaging.cn>

Customer Service Center:

10F, K, Wah Centre, 1010 Huaihai Road(M), Xuhui District, Shanghai

Zip: 200031

OLYMPUS HONG KONG AND CHINA LIMITED

Digital Camera Repair Centre

L4207, Office Tower, Langham Place, 8 Argyle Street, Mongkok, Kowloon, Hong Kong

Customer Hotline: +852-2376-2150 Fax: +852-2375-0630

E-mail: cs.ohc@olympus-ap.com

<http://www.olympus.com.hk>